



Executive
& Conference Furniture

Information library



B2B Platform



Order MARO products on our B2B platform!

Zamów produkty MARO na naszej platformie B2B.

Bestellen Sie direkt über unsere B2B-Plattform!



Photobank



Download all the necessary materials from our base.

Pobierz wszystkie potrzebne materiały z naszej bazy!

Hier finden Sie Materialien zum Download.



pCon



Start your adventure with a professional interior design tool.

Już dziś zacznij przygodę z profesjonalnym narzędziem do projektowania wnętrza.

Starten Sie ins Abenteuer mit dem professionellen Raumplaner.



Website



Visit our website to stay up to date!

Odwiedź naszą stronę i bądź na bieżąco.

Auf dem Laufenden bleiben? Besuchen Sie uns online!



Order samples



Fill in the form and order samples from our latest color scheme.

Wypełnij formularz i zamów próbki z aktualnego wzornika kolorystycznego.

Füllen Sie das Formular aus und bestellen Sie Muster aus unserer aktuellen Farbkarte.



Consultation with our architect



We will draw up a projection with an office design tailored to your needs.

Przygotujemy dla Ciebie rzut z aranżacją według Twoich potrzeb.

Wir erstellen für Sie ein Bürokonzept ganz nach Ihren Bedürfnissen.



Product training

Training courses on MARO offer for our distribution partners

Kurs i szkolenia z oferty produktowej MARO dla naszych dystrybutorów

Produktschulung und Training für unsere Partner



Since 1991 **MARO Office Furniture** has been the pioneer in creating equipment for modern office interiors. MARO is synonymous with the highest quality and functionality combined with the leading-edge design and innovative technology. The focus based on building close rapports with our clients due to the high level of expertise and experience has established our reputation as a top-class and reliable partner. Our long-standing presence on numerous international markets certifies our widespread recognition.

Vision

A family-run furniture company with a global reach where passion and experience translate into tailor-made solutions for each Client.

Mission

Taking advantage of our knowledge, technology and many years of experience, we design, manufacture and deliver customized, top quality furniture solutions. We equally lay emphasis on being environmentally friendly and respecting people. We desire to make working anywhere in the world as comfortable, efficient and ergonomic as possible.

CONTENTS



Executive & Conference Furniture

08

AXY-Line

A type 08 | Y type 12 | X type 16 | AXY-Line Mobile 18 | complete collection specification 20 |

24

L-Line

conference tables 24 | complete collection specification 32 |

34

Ario

desks 34 | conference tables 46 | complete collection specification 50 | Ario colors 52 |

54

Sirio

desks 54 | conference tables 60 | Sirio Mobile 64 | complete collection specification 66 |

70

Toris

desks 70 | conference tables 76 | complete collection specification 78 |

80

Graf

conference tables 82 | desks 86 | complete collection specification 88 |

90

Fineze

shelf units 90 | complete collection specification 94 |

96

Lusso

occasional tables 96 | complete collection specification 100 |

104

Accessories

accessories 104 | complete collection specification 108 |

Three unique bases



AXY-Line A
Conference table

AXY-Line

Let's meet
in a beautiful space

AXY-Line

EN | AXY-Line is a collection that stands out for its contemporary style and unique detailing. It includes versatile conference and executive furniture: tables, desks, cabinets and showcases. At MARO, we are aware of the importance of diversity, and therefore offer three types of legs: A-, X- and Y-shaped. Each of them will give your space a distinct touch.

PL | AXY-Line to kolekcja wyróżniająca się nowoczesnością i dbałością o szczegóły. Obejmuje uniwersalne meble konferencyjno-gabinetowe: stoły, biurka, szafy i witryny. W MARO wiemy, jak ważna jest różnorodność, dlatego oferujemy trzy typy nóg – w kształcie litery A, X i Y. Każdy z nich nada przestrzeni inny charakter.

DE | AXY-Line ist eine Kollektion, die sich durch ihren modernen Stil und einzigartige Details auszeichnet. Sie umfasst universelle Konferenz- und Managementmöbel wie Tische, Schreibtische, Schränke und Vitrinen. Wir bei MARO sind uns dessen bewusst, wie wichtig die Vielfalt ist, und bieten drei Gestellvarianten: A, X und Y. Jede Variante verleiht dem Raum einen anderen Charakter.

A type



Y type



X type





AXY-Line A
Conference table



AXY-Line Y

EN | Y-shaped legs have a unique design and are made of superior quality materials.

PL | Noga w kształcie litery Y odznacza się niepowtarzalnym designem, skupieniem na szczegółach i doskonałej jakości wykonaniem.

DE | Das Y-Fußgestell überzeugt mit seinem einzigartigen Design, Liebe zum Detail und hervorragender Ausführungsqualität.

AXY-Line Y
1 | Desk 2 | Conference table 3 | Showcase



EN | If you want your office area to be stylish and also provide your employees with a comfortable work environment, opt for AXY-Line collection from MARO.

PL | Jeżeli chcesz, by Twoja przestrzeń biurowa kojarzyła się z elegancją, a przy tym zapewniała pracownikom komfortowe warunki, postaw na kolekcję AXY-Line od MARO.

DE | Sollen Ihre Büroräume Eleganz ausstrahlen und gleichzeitig ein komfortables Umfeld für Ihre Mitarbeiter bieten? Setzen Sie auf AXY-Line von MARO.



1

2



AXY-Line Mobile
Conference table

AXY-Line Mobile
perfect solution
for dynamic meetings,
presentations
and training courses

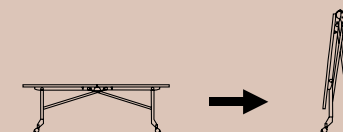

EN | AXY-Line Mobile conference table is equipped with a mechanical folding system that allows one person to fold it without the slightest difficulty. The mobile table can be fitted with a dry-wipe top that can work as a whiteboard.

PL | Stół konferencyjny AXY-Line Mobile posiada mechaniczny system składania oraz rozkładania, dzięki któremu złożyć go jedna osoba – i to bez najmniejszego trudu. Stół mobilny można wyposażyć w blat z powierzchnią do pisania, pełniącą funkcję przenośnej tablicy.

DE | Der Konferenztisch AXY Mobile ist mit einem Klappmechanismus ausgestattet, dank dem die Bedienung kinderleicht wird. Ausgeführt in trocken abwischbarer Oberfläche, kann die Tischplatte als mobiles Whiteboard genutzt werden.

Conference tables

Stoly konferencyjne — Konferenztische

H: 740 mm

A type

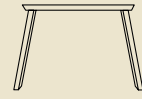

X type



Y type



Table top

Kształty blatów — Tischplattenformen

H: 740 mm

1600 - 2400
every 100

2800 - 4800
every 100

1600 - 2400
every 100

2800 - 4800
every 100

1600 - 2400
every 100

2800 - 4800
every 100

1600 - 2400
every 100

2800 - 4800
every 100

rectangular

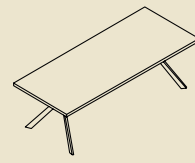
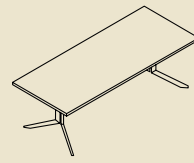
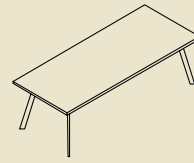

rounded corners

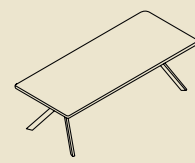
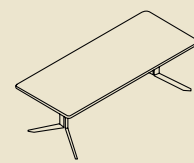
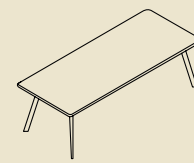

barrel-shaped

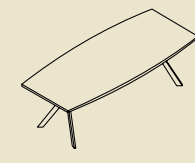
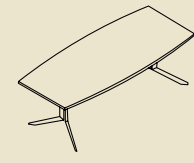
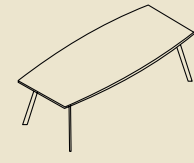

oval

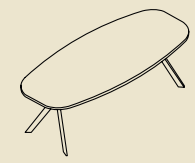
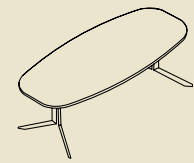
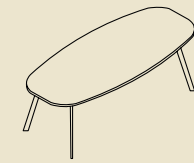
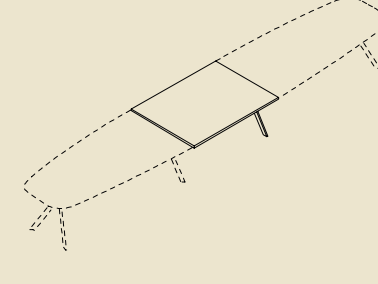
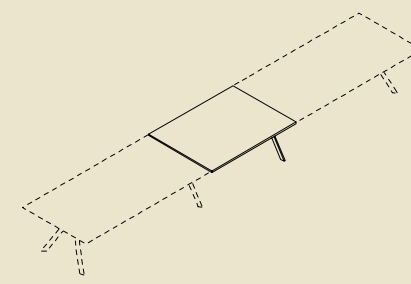

Table extension modules

Moduły wydłużające — Erweiterungsmodule



1400/1600/
2000

1400/1600/
2000

Desks*

Biurka — Schreibtische

H: 740 mm

1400 - 2400
every 100

1400 - 2400
every 100

rectangular

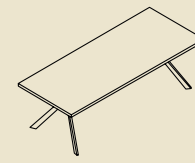
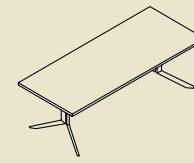
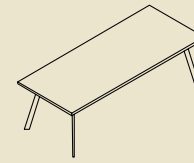

rounded corners

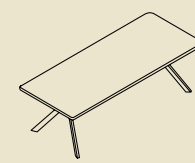
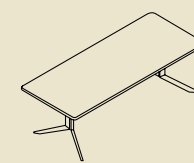
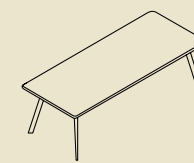

* Available from the second quarter of 2023.

Cabinets

Szafy gabinetowe — Schränke

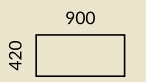
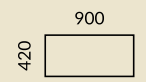
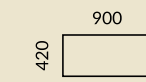
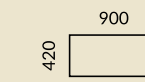
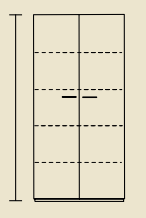
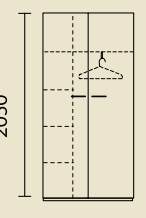
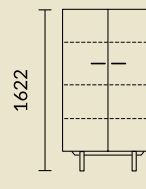
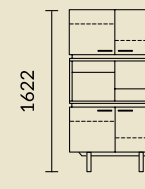
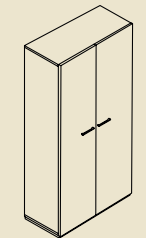
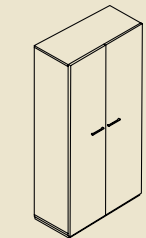
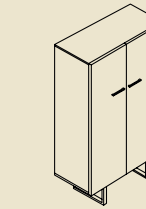
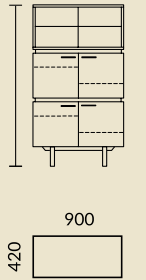
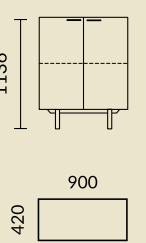
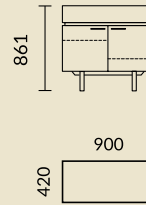
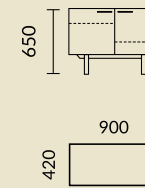
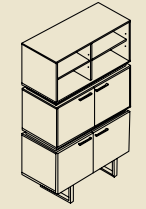
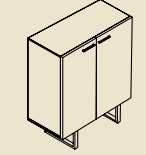
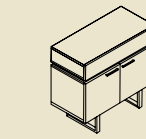
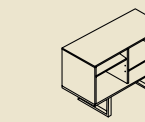

Showcases

Witryny gabinetowe — Vitrinen

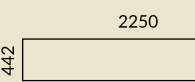
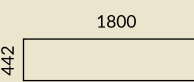
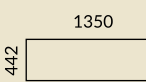
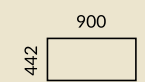
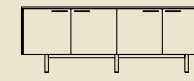
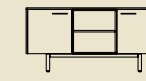
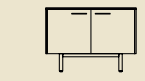
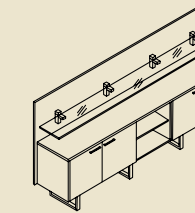
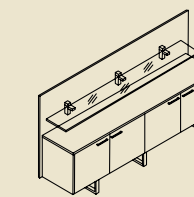
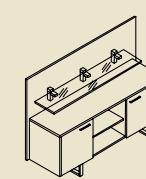
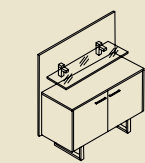

Occasional tables

Stoły okolicznościowe — Besprechungstische

H: 740 mm

		type A	type X	type Y
square	1000/1200 1400			
rounded corners	1000/1200 1400			
round	Ø 1000/1200 1400			

High occasional tables

Stoły okolicznościowe wysokie — Hohe Besprechungstische

H: 1100 mm

rectangular	1400/1600/ 1800/2000 1000/1200	
square	1000/1200/ 1400	

Low occasional tables

Stoły okolicznościowe niskie — Niedrige Besprechungstische

H: 500 mm

rectangular	1200/1400/1600 800	
square	800/1000/1200/ 1400	
round	Ø 800/1000/1200	

AXY-Line Mobile

H: 729 mm / 735 mm

rectangular	2800/3000/3200 1000/1200	
rounded corners	2800/3000/3200 1000/1200	
barrel-shaped	2800/3000/3200 1000/1200	

Table folding

Składanie stołu — Klappmechanismus

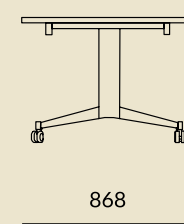
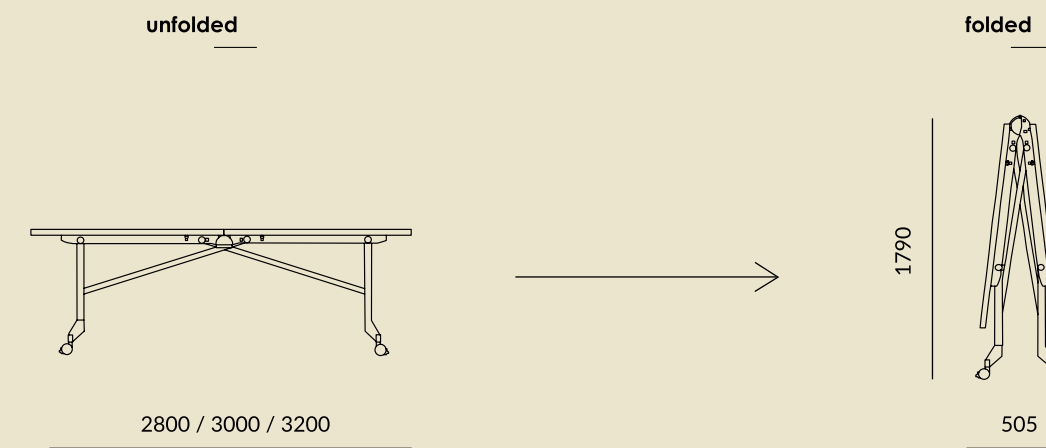

Notes



1 | L-Line - Conference table 2 | Fineze Tri - Shelf unit

Vast selection of shapes and sizes

L-Line

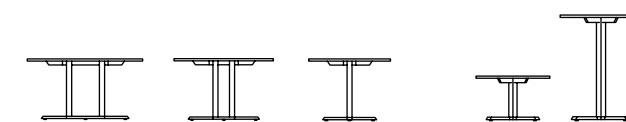

EN | L-Line collection offers a variety of conference and occasional tables, which will help you organize any business meeting. The unique leg shape matches the desks from MARO's workstation collection. Thanks to this, your office space design will remain consistent.

PL | Kolekcja L-Line zawiera rozmaite stoły oraz stoliki konferencyjne i okolicznościowe, które pozwolą zaaranżować spotkanie biznesowe. Wyjątkowy kształt nóg nawiązuje do biurek z kolekcji pracowniczych z oferty MARO – dzięki temu, przestrzeń biurowa nabiera spójnego charakteru.

DE | Die Kollektion L-Line bietet eine Vielzahl von Konferenz- und Beistelltischen, die sich bei der Organisation jeder Geschäftsbesprechung als behilflich erweisen. Die einzigartige Beinform passt zu den Schreibtischen der Arbeitsplatzkollektionen von MARO, wodurch ein stimmiges Gesamtbild der Büroräume entsteht.

L-Line



1 | L-Line - Conference table 2 | Fineze Tri - Shelf unit 3 | Wariant - TV stand



EN | L-Line conference table enables you to hide cables in a table leg. Thus, the entire piece looks aesthetically pleasing.

PL | Stół konferencyjny L-Line umożliwia ukrycie okablowania poprzez umieszczenie go w nodze, dzięki czemu całość prezentuje się naprawdę estetycznie.

DE | Die im Tischbein integrierte Kabelführung lässt den Kabelchaos vermeiden und den Konferenztisch L-Line besonders ästhetisch wirken.

L-Line
Conference table



1 | L-Line - Conference table 2 | System-eM TV stand

Conference table

Unique design and distinctive chrome finish will give your office a timeless touch of elegance

EN | We offer conference tables in various shapes: square and round ones. Our collection also features one- and two-piece models. They can be equipped with dedicated extension modules. Thanks to our broad portfolio, every single client will find a table that meets his or her expectations.

PL | Oferujemy stoły konferencyjne w różnych kształtach: kwadratowe i okrągłe. W naszej kolekcji znalazło się też miejsce na modele jedno- i dwuelementowe. Specjalne moduły wydłużające pozwalają na ich rozbudowywanie. Dzięki bogatemu asortymentowi każdy klient znajdzie stół, który spełni jego oczekiwania.

DE | Wir bieten Konferenztische in verschiedenen Formen - mit quadratischer und runder Tischplatte. Die Kollektion umfasst sowohl ein- als auch zweiteilige Tischvarianten. Die zweiteiligen Modelle können mit zusätzlichen Elementen erweitert werden. In unserem Produktprogramm findet jeder Kunde einen Tisch, der seinen Erwartungen entspricht.

Conference tables

Stóły konferencyjne — Konferenztische

H: 740 mm

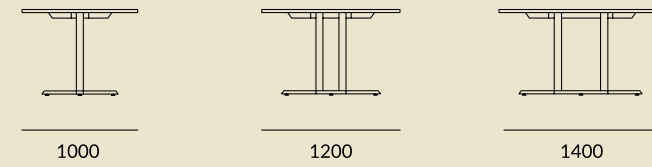
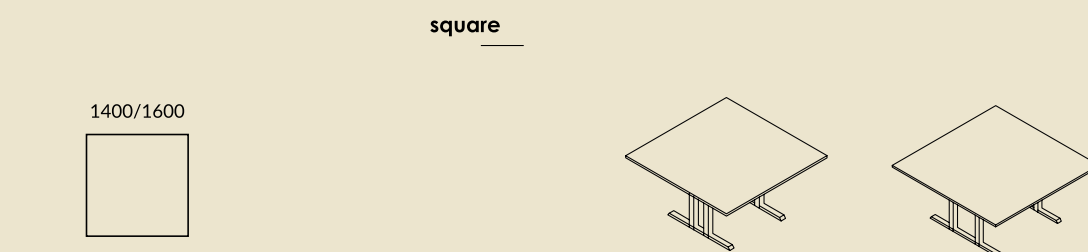
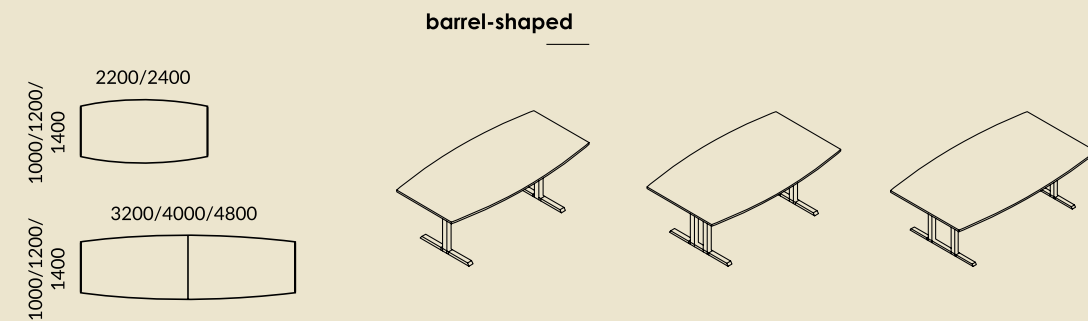
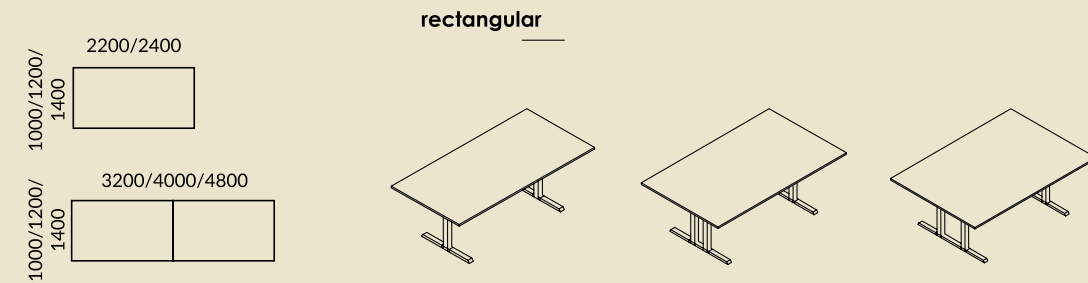

Table shapes

Kształty blatów — Tischplattenformen

H: 740 mm



Occasional tables

Stóły okolicznościowe — Beistelltische

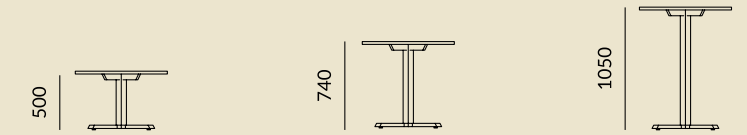

Table shapes

Kształty blatów — Tischplattenformen

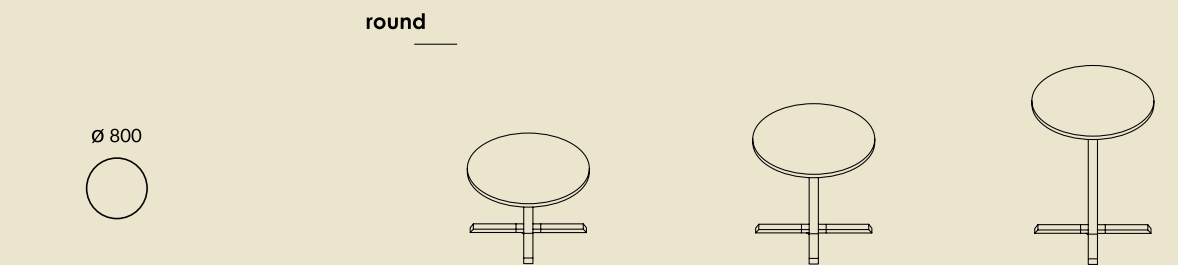
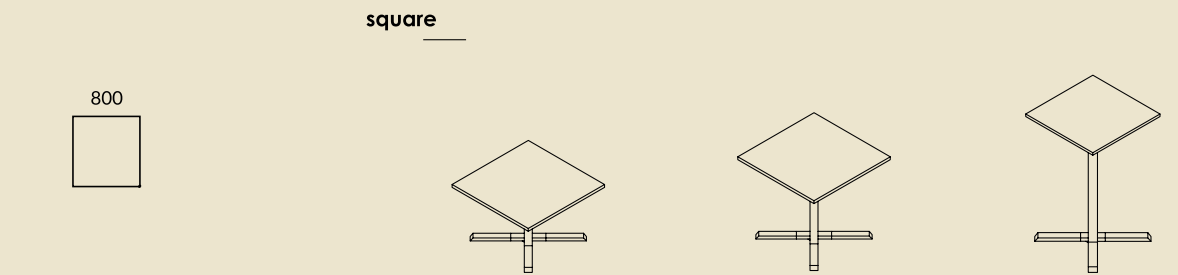
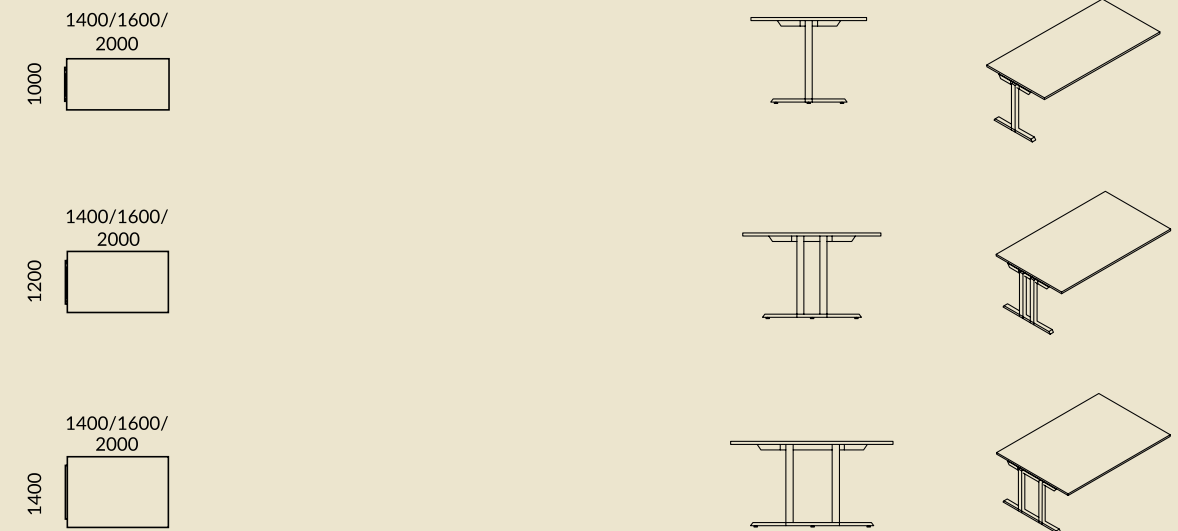

Table extension modules

Moduły wydłużające — Erweiterungsmodule

H: 740 mm





Ario
1 | Desk supported on sideboard 2 | Showcase 3 | Occasional table

Variety of fabrics, second
to none workmanship
and ergonomics of use

Ario

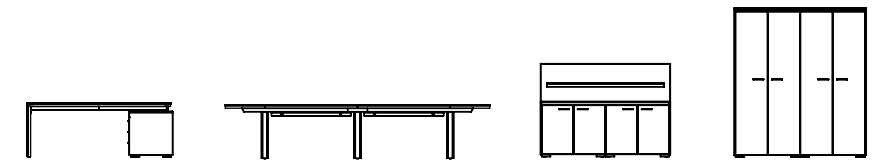

EN | Ario is a unique collection of office furniture distinguished by its original finishes and detailing. It has been created with nature inspired materials. Choose the furniture from this line to furnish your executive office or conference space.

PL | Ario to wyjątkowa kolekcja mebli gabinetowych, których znakiem rozpoznawczym są niebanalne wykończenia i skupienie na detalach. Zostały wykonane z materiałów inspirowanych naturą, dlatego pomogą zaaranżować przestrzeń gabinetową czy konferencyjną.

DE | Ario ist eine exklusive Büromöbelkollektion, die sich durch ihre originellen Oberflächen und Details auszeichnet. Die von der Natur inspirierten Materialien eignen sich perfekt für Gestaltung von Chefbüros und Konferenzräumen.



Ario

1 | Desk with high adjustment 2 | Cabinets 3 | Showcase



Electric high adjustment

Combination of modern ergonomics and timeless elegance

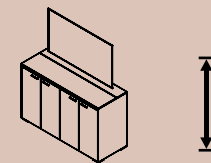
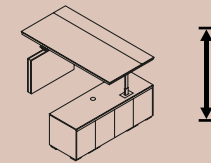

EN | Keen on innovative solutions? Ario is the right choice for you. This collection includes a desk with electric height adjustment and a cabinet with an electrically retractable TV holder.

PL | Zależy Ci na innowacyjnych rozwiązaniach? Kolekcja Ario to coś dla Ciebie. Znajdziesz w niej biurko z elektryczną regulacją wysokości czy szafkę z elektrycznie wysuwającym uchwytem na telewizor.

DE | Sind Sie an innovativen Lösungen interessiert? Dann ist Ario die richtige Wahl für Sie. In dieser Kollektion finden Sie auch elektromotorisch höhenverstellbare Schreibtische und einen TV-Schrank mit elektrisch versenkbarer Bildschirmhalterung.

Ario
1 | Desk with high adjustment 2 | TV cabinet 3 | Showcase



EN | Office space should not solely be functional, but also aesthetic. Opt for sophisticated elegance, unconventional solutions and lightness as well as a stable structure.

PL | Przestrzeń biurowa powinna być nie tylko funkcjonalna, ale również estetyczna. Postaw na niewymuszoną elegancję, nieszablonowe rozwiązania i lekkość oraz stabilność konstrukcji.

DE | Die Büroumgebung soll nicht nur funktional, sondern auch ansprechend sein. Lassen Sie sich von ungezwungener Eleganz, unkonventionellen Lösungen, Leichtigkeit sowie von robuster Konstruktion überzeugen.

Ario

1 | Desk supported on sideboard 2 | Cabinets 3 | Occasional table 4 | Conference table



3

1

2



Ario
1 | Desk with conference extension 2 | Showcases 3 | Minibar showcase

EN | Electrically retractable Ario mini bar serves as a perfect example of an innovative and functional piece that can perfectly complement your office space.

PL | Elektrycznie chowany barek Ario to przykład innowacyjnego i funkcjonalnego elementu przestrzeni, który doskonale dopełni całość aranżacji.

DE | Der Minibarschrank Ario mit elektrisch versenkbarem Tablar-system ist ein perfektes Beispiel, wie man Büroräume innovativ und funktional ergänzen kann.



Ario
Conference table



Conference table

EN | Ario conference tables come in a variety of finishes and are available with a plethora of useful accessories. This makes it easy to suit the client's needs. At MARO, we offer one- and two-piece tables.

PL | Stoły konferencyjne z kolekcji Ario odznaczają się różnorodnością dostępnych wykończeń oraz praktycznych akcesoriów, dzięki czemu łatwo dopasować je do potrzeb danego klienta. W MARO oferujemy stoły jedno- i dwuelementowe.

DE | Die unterschiedlichen Ausführungsvarianten und das praktische Zubehör lassen die Konferenztische aus der Kollektion Ario je nach Wunsch anpassen. MARO bietet sowohl einteilige als auch zweiteilige Konferenztische.



1

2

Executive office desks

Biurka gabinetowe proste — Managerschreibtische

H: 750 mm

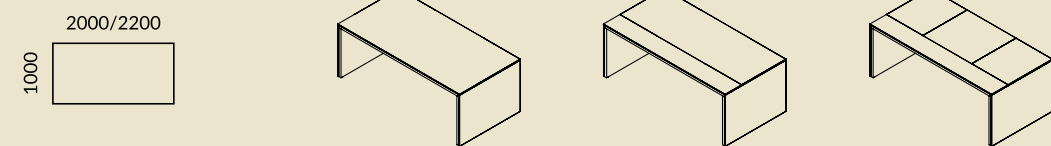

Desks supported on cabinet

Biurka wsparte na szafce
Managerschreibtische mit integriertem Sideboard

H: 750 mm

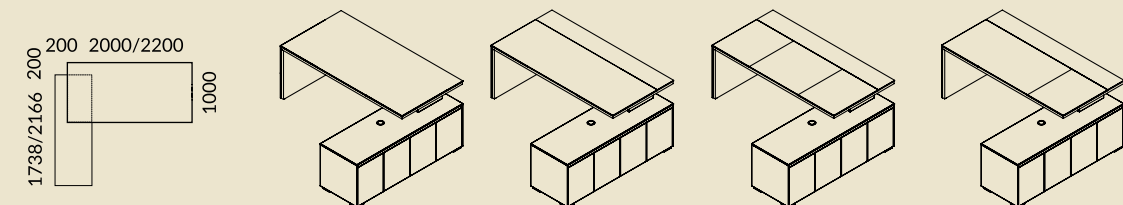

Desks with conference extension

Biurka z modułem konferencyjnym
Managerschreibtische mit Konferenzansatz

H: 750 mm

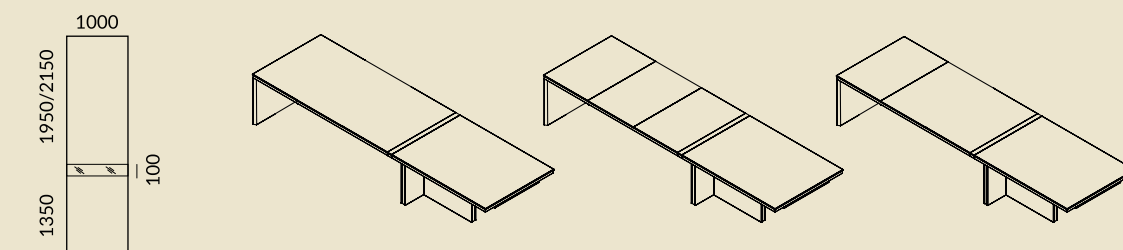

Desks supported on sideboards with conference extensions

Biurka z modułem konferencyjnym wsparte na szafce
Managerschreibtische mit Sideboard und Konferenzansatz

H: 750 mm

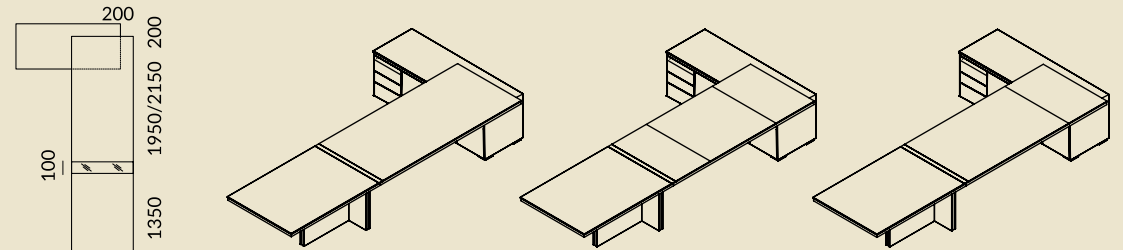

Modesty panel

Zabudowa
Knieblenden

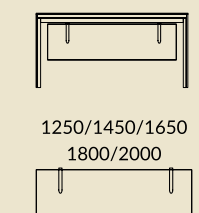

Sideboards

H: 632 mm

Szafki podbiurkowe
Unterbausideboards

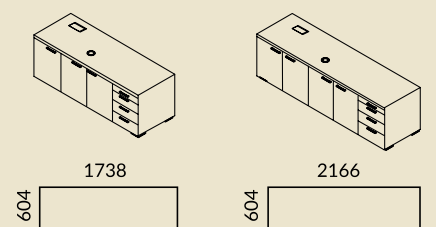

Desks with electric height adjustment

Biurka z elektryczną regulacją wysokości
Elektromotorisch höhenverstellbare Schreibtische

H: 750 - 1250 mm

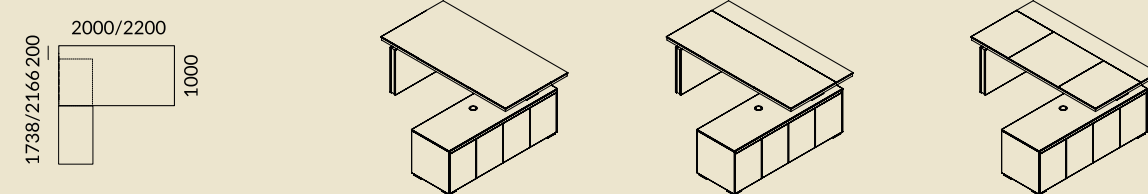

Conference tables

Stoły konferencyjne — Konferenztische

H: 750 mm

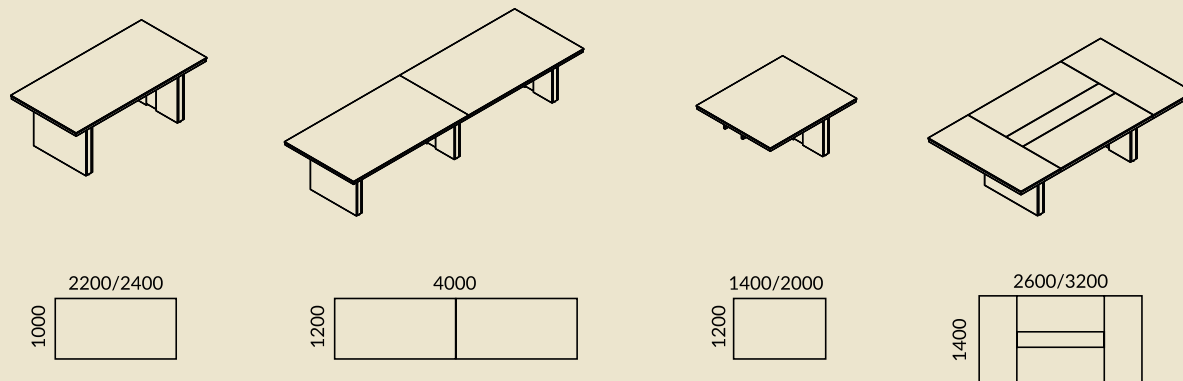

Extension

Occasional table

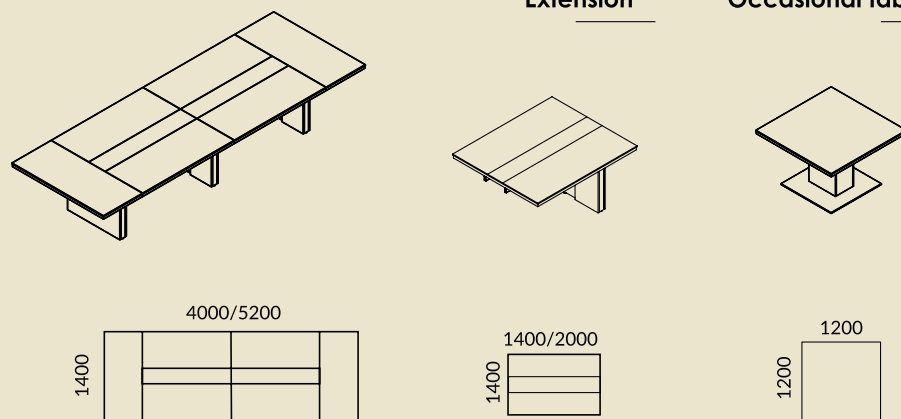

Mobile pedestals

Kontenery mobilne
Rollcontainer

H: 557 mm

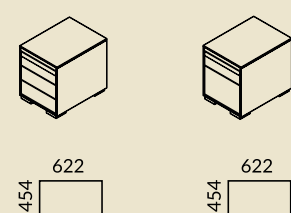

Occasional tables

H: 450 mm

Stoliki okalniczościowe
Beistelltische

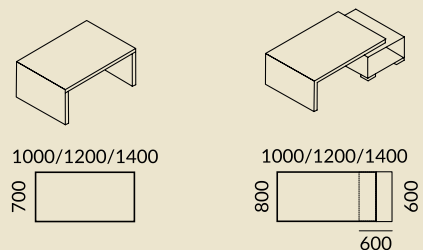

Showcases

Witryny gabinetowe — Vitrinen

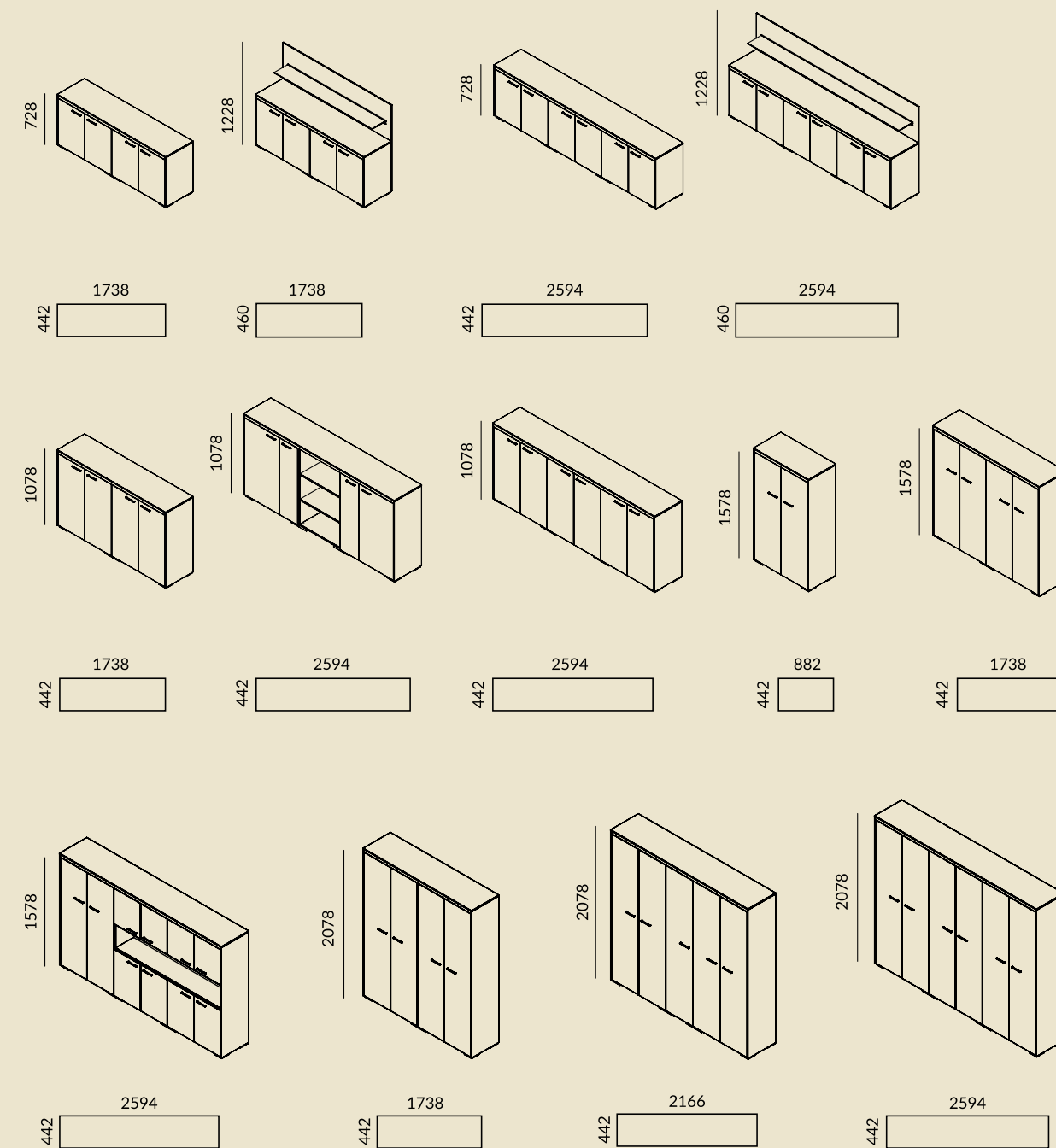

Minibar

H: 1078 mm

Barek
Minibarschrank

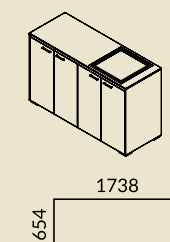

TV Cabinet

H: 1078 mm

Szafka TV
TV-Schrank

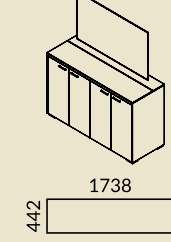

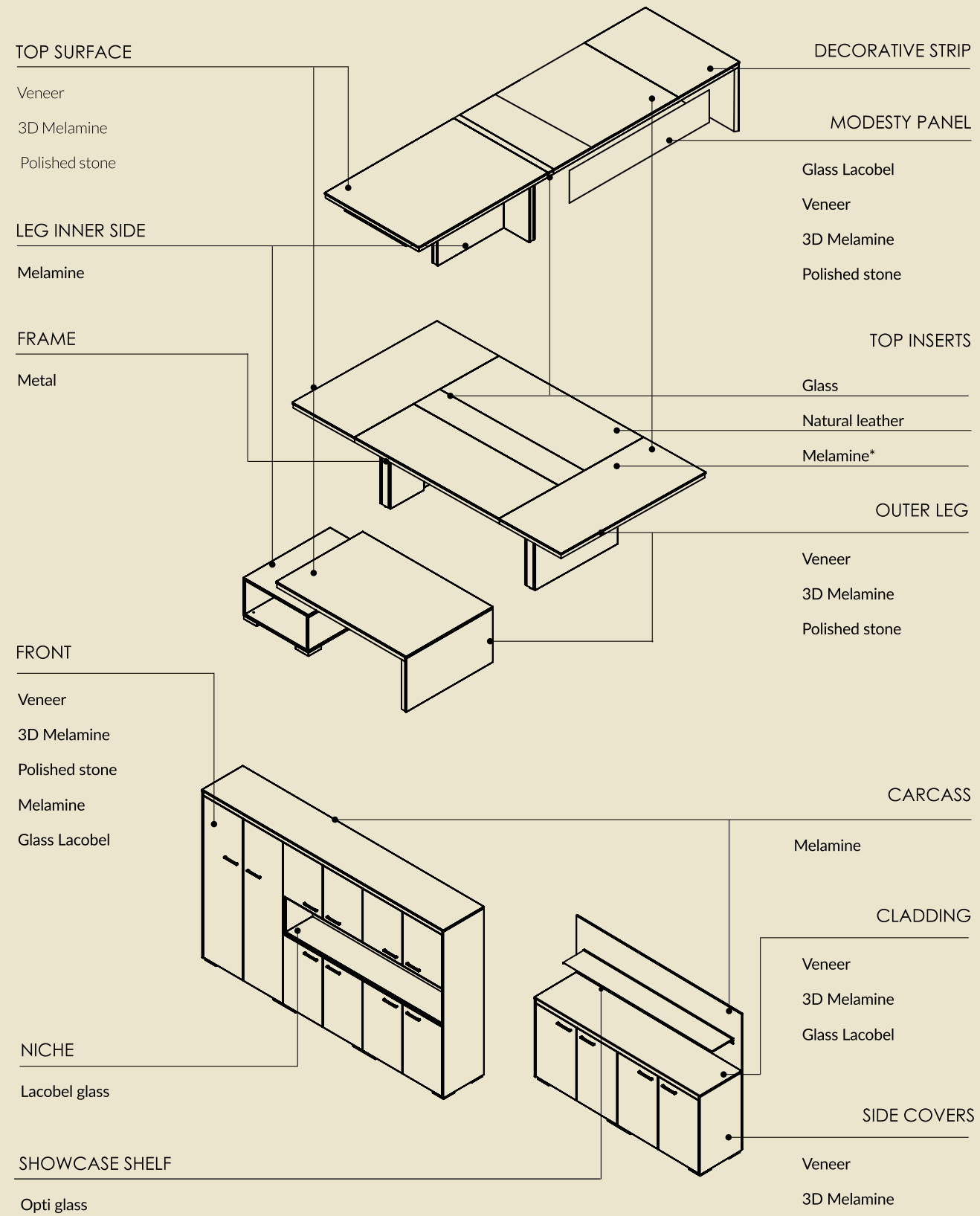



1 | Desk supported on sideboard 2 | Sideboard 3 | Showcase

Sirio

Sirio

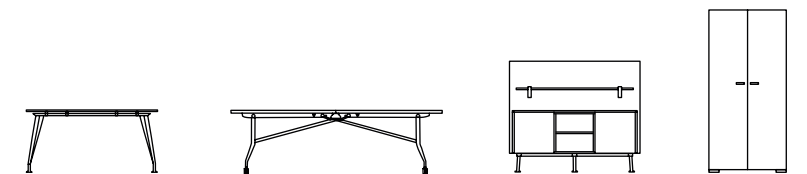

EN | Sirio collection offers everything you need to furnish your office or an executive room. It combines a trendy, modern design, which gives the impression of lightness, with a multitude of handy functions. The furniture also features tables and desks with legs in extraordinary shapes.

PL | Kolekcja Sirio zawiera wszystko, czego potrzeba do kompleksowego wyposażenia biura czy gabinetu. Łączy w sobie modny, nowoczesny design, który daje wrażenie lekkości, oraz wielość przydatnych funkcji. Meble wyróżniają się smukłym, nietuzinkowym kształtem nóg.

DE | Die Kollektion Siro lässt jedes Büro oder Chefzimmer komplett ausstatten. Sie vereint modernes, leicht wirkendes Design mit einer Vielzahl von nützlichen Funktionen. Die Möbel zeichnen sich durch die schlanke, unkonventionelle Form der Beine aus.



1 | Desk supported on sideboard 2 | Sideboard 3 | Conference table 4 | Occasional table 5 | Showcases

Sirio



Sirio
1 | Desk supported on sideboard 2 | Sideboard 3 | Showcase 4 | High cabinet



EN | A remarkable office design will help you make the most of your office space as well as give it a sophisticated touch. Moreover, your work will also become more enjoyable.

PL | Wyjątkowa aranżacja pomoże w pełni zagospodarować przestrzeń i nadać jej wysmakowanego charakteru, dzięki czemu praca stanie się przyjemniejsza.

DE | Ein einzigartiges Bürokonzept hilft die Büroumgebung optimal gestalten und verleiht ihm eine anspruchsvolle Note. Die Arbeit wird dadurch viel angenehmer.

Conference table

Unique design and distinctive chrome finish will give your office a timeless touch of elegance

Sirio

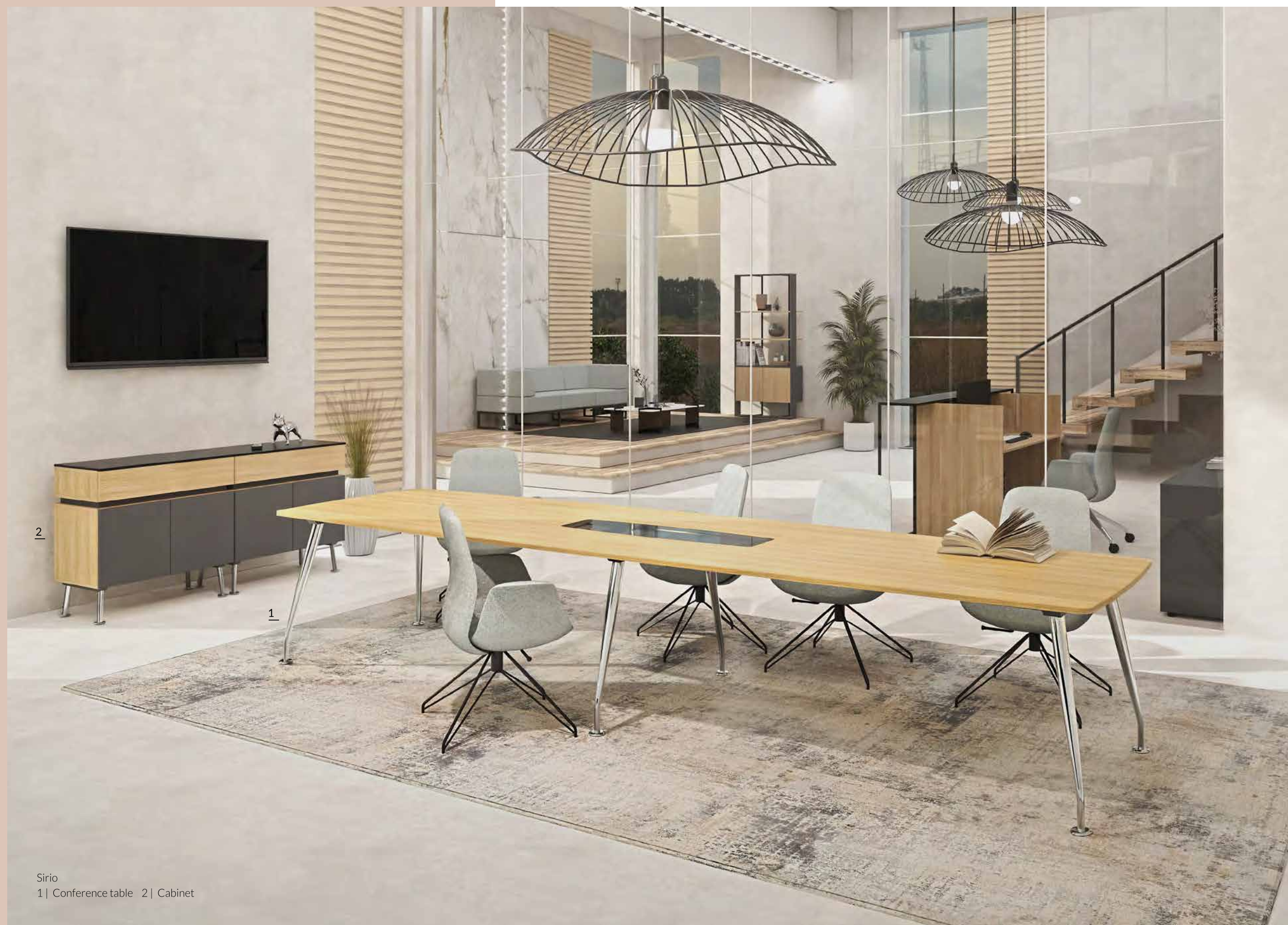

Sirio
1 | Conference table 2 | Cabinet

EN | Sirio tables are made with care and attention to detail. They seem exceptionally lightweight thanks to their leg structure.

PL | Nogi z kolekcji Sirio zostały wykonane z należytą starannością i troską o detale, dzięki czemu pozwalają na stworzenie lekkiej konstrukcji.

DE | Die Tischbeine aus der Kollektion Sirio werden mit Sorgfalt und Liebe zum Detail hergestellt, wodurch das Gestell besonders leicht wirkt.



Sirio

Sirio
1 | Conference table 2 | Cabinet



Sirio Mobile

It is a multifunctional piece of furniture, which after folding takes up only 40 cm.

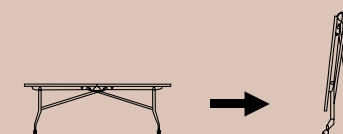

EN | Mobile legs are not only slim, but also highly functional – they allow you to move the table from one place to another without difficulty.

PL | Mobilne nogi są nie tylko smukłe, ale też funkcjonalne – umożliwiają bezproblemowe przeniesienie stołu z miejsca na miejsce.

DE | Die Tischbeine auf Rollen sind nicht nur schlank, sondern auch sehr praktisch – sie lassen den Tisch bei Bedarf problemlos umstellen.

Executive desk

Biurko gabinetowe — Managerschreibtisch

H: 750 mm

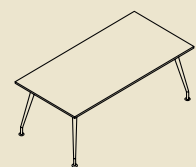
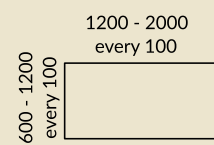

Team desk

Stanowisko wieloosobowe
Teamarbeitsplatz

H: 750 mm

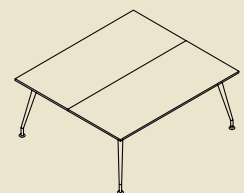
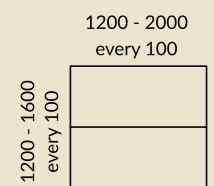

Add-on desk

Przystawka
Anbautisch

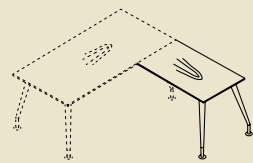
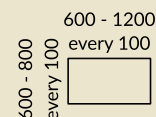

Supported on sideboard

Wsparte na szafce — Mit integriertem Sideboardgetragen

H: 750 mm

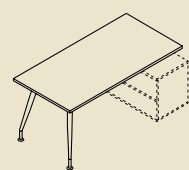
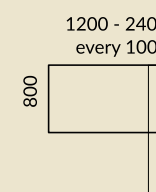
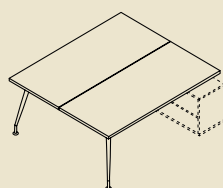
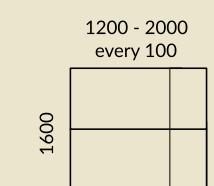

Underdesk sideboards

Szafki podbiurkowe — Unterbausideboards

H: 633 mm

shelf unit

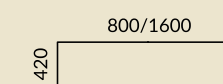
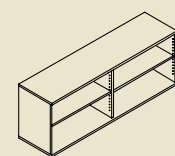

with sliding doors

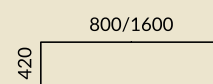
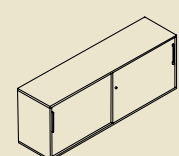

double-sided

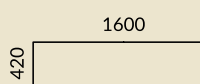
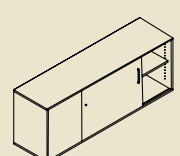

combi

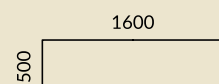
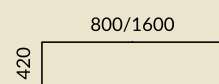
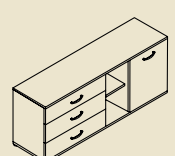

Conference tables

Stoły konferencyjne — Konferenztische

H: 750 mm

rectangular

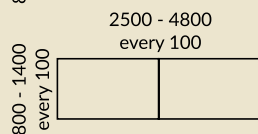
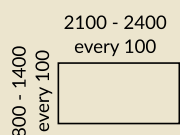
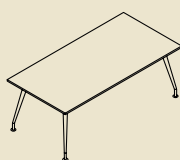

barrel-shaped

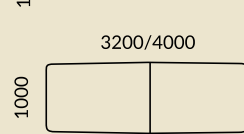
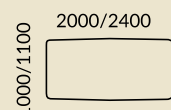
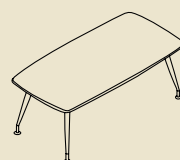

with glass insert

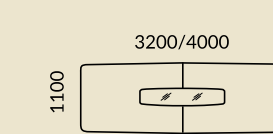
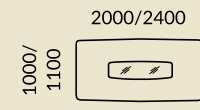
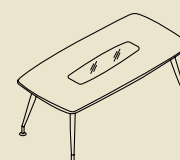

multi-piece

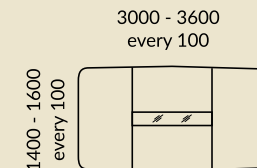
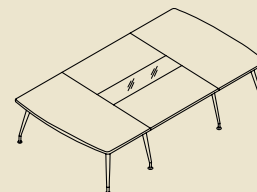

media table

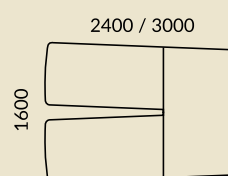
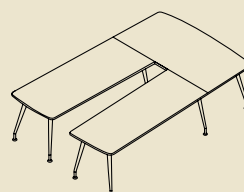

Sirio Mobile

H: 728 mm / 735 mm

rectangular

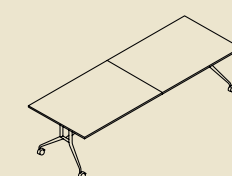
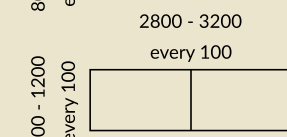
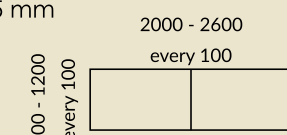

rounded corners

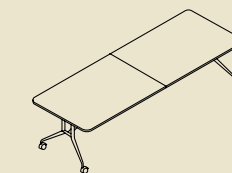
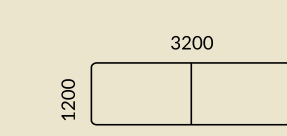
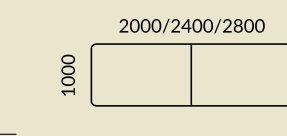

unfolded



folded



1567/1896

370

Occasional tables

Stoły okolicznościowe — Besprechungstische

H: 750 mm

square

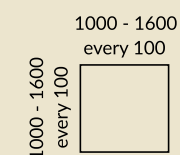
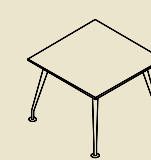

round

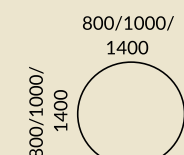
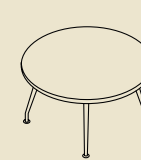

triangular

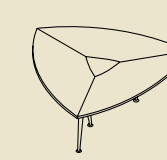

round, shaped

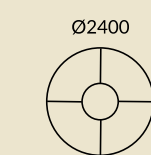
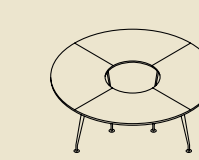

glass, oval

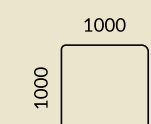
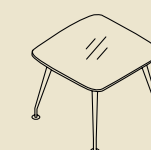

Low occasional table

Stół okolicznościowy niski — Niedriger Beistelltisch

H: 500 mm

round

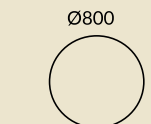
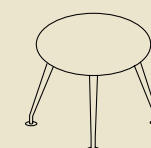

Showcases

Witryny gabinetowe — Vitrinen

H: 662 mm

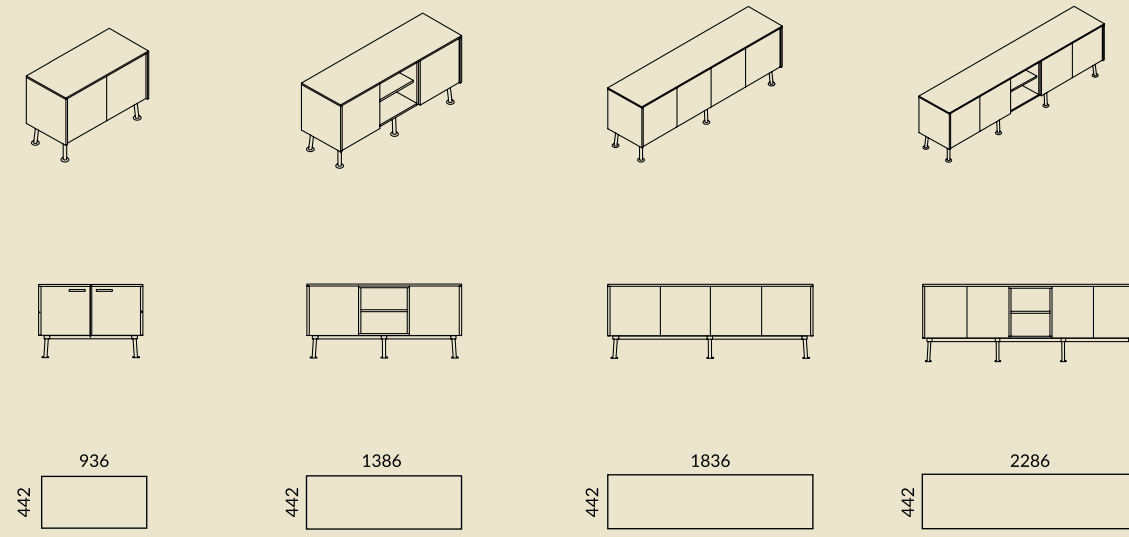

H: 1200 mm

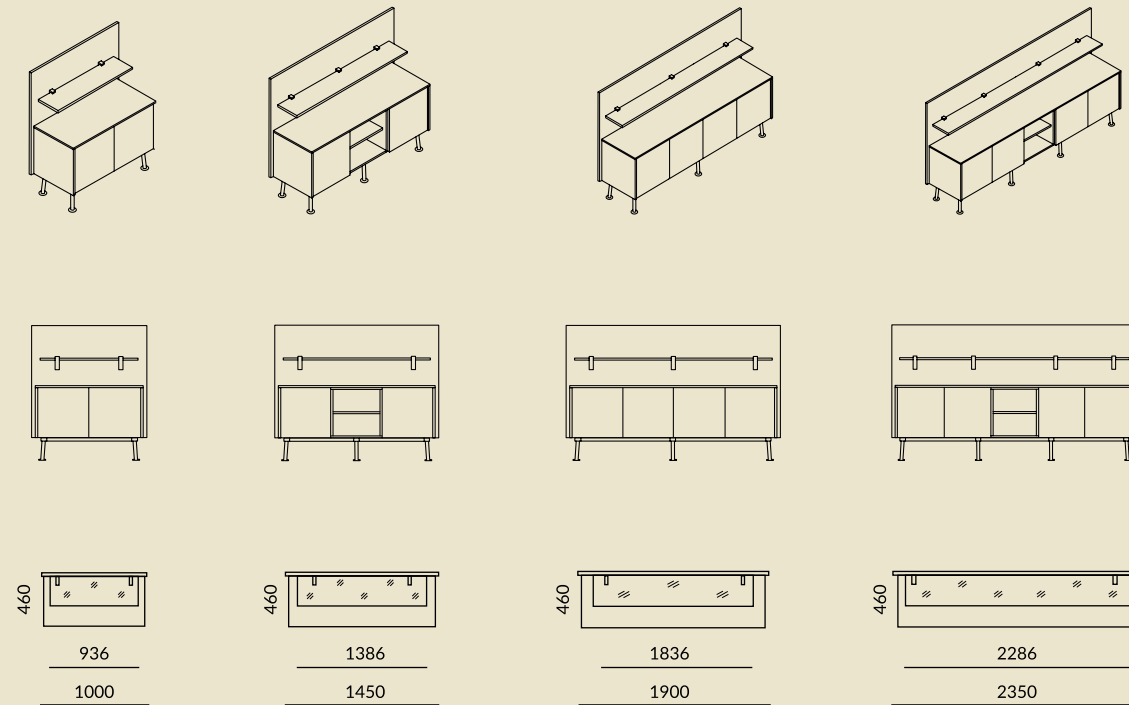

Low cabinets

Szafy gabinetowe niskie — Niedrige Schränke

H: 662 mm

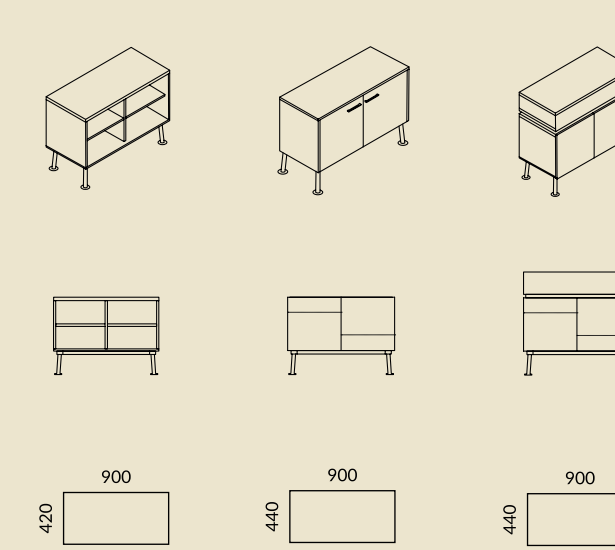

Medium cabinet

Szafa gabinetowa średnia — Mittelgroßer Schrank

H: 1148 mm

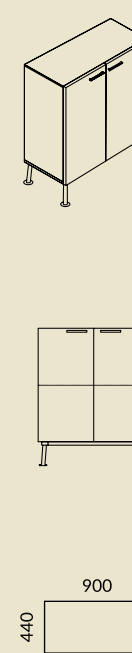

High cabinets

Szafy gabinetowe wysokie — Hohe Schränke

H: 1622 mm

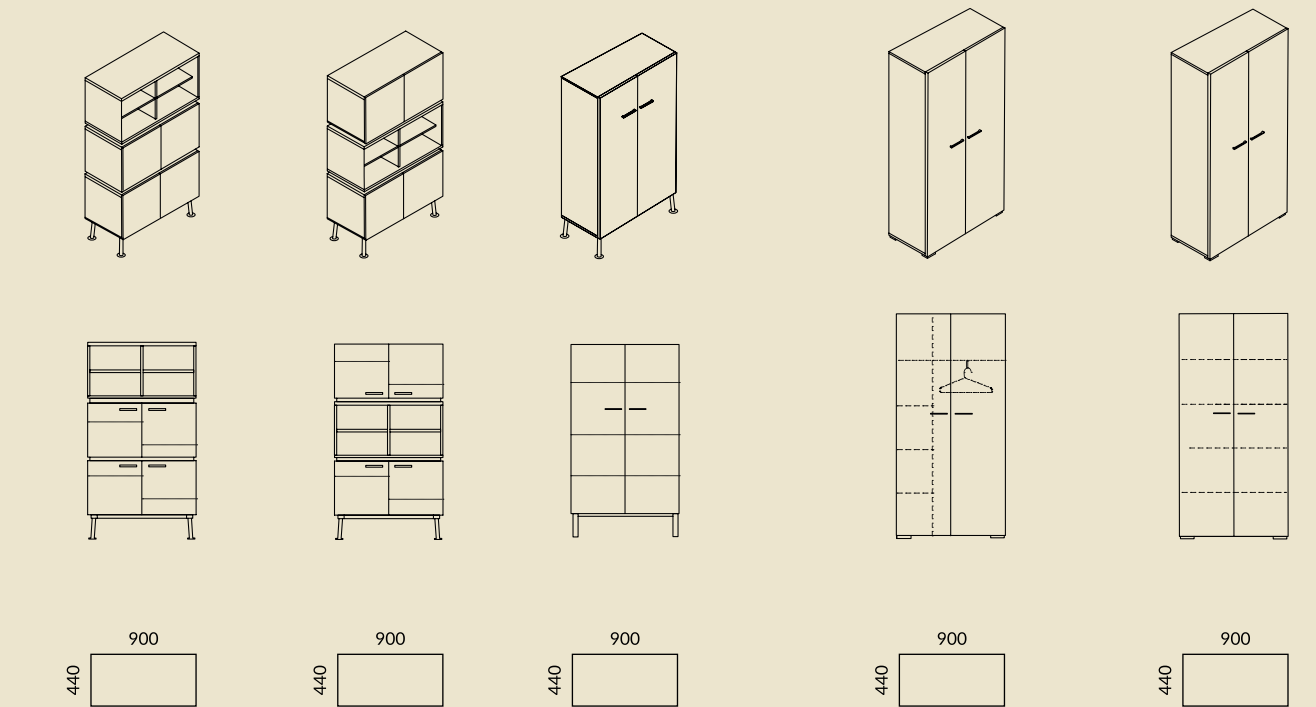

H: 1880 mm



1 | Toris - Desk supported on sideboard 2 | Toris - Sideboard 3 | PRO - Cabinet with hinged doors

Toris

The combination of two different decors creates a unique effect.

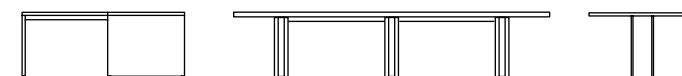

EN | Toris collection features executive desks as well as conference and occasional tables. The furniture's hallmark are geometric, simple forms, therefore it goes in line with minimalist trends in office design. However, it will also suit more avant-garde spaces.

PL | Kolekcja Toris obejmuje biurka gabinetowe, stoły konferencyjne i stoły okolicznościowe. Meble z tej linii zostały utrzymane w geometrycznych, prostych formach, dlatego znakomicie wpasowują się w modę na minimalizm. Będą pasować także do bardziej awangardowych przestrzeni.

DE | Die Kollektion Toris umfasst Managementschreibtische, Konferenz- und Besprechungstische. Die geometrischen, einfachen Formen der Kollektion fügen sich perfekt in den Trend des Minimalismus ein. Sie passen aber auch in moderne, ungewöhnliche Bürokonzepte.



1

2

3

1 | Toris - Desk supported on sideboard 2 | Toris - Sideboard 3 | PRO - Cabinet with hinged doors with add-on unit



1 | Toris - Desk supported on sideboard 2 | Toris - Sideboard 3 | PRO - Cabinet with hinged doors

EN | Toris furniture is multifunctional, which is its greatest advantage. It can easily be placed in any type of office space.

PL | Meble z kolekcji Toris są niezwykle uniwersalne, co stanowi ich największy atut. Można je umieścić w każdej przestrzeni biurowej.

DE | Die Möbel aus der Kollektion Toris sind multifunktional, was ihr größter Vorteil ist. Sie lassen sich problemlos in jedes Bürokonzept integrieren.

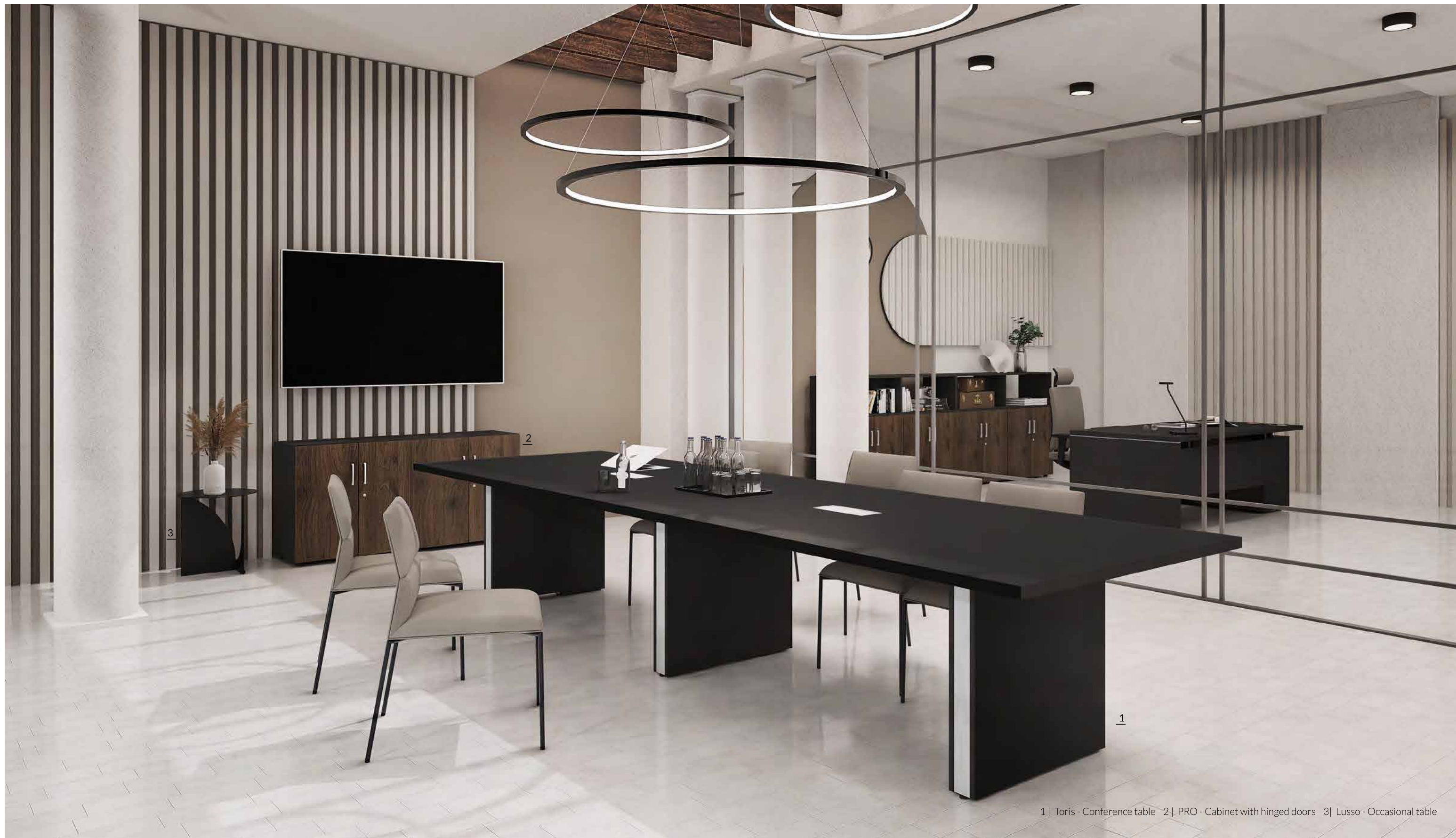

Toris

Executive desks

Birka gabinetowe — Managerschreibtische

H: 750 mm

desk

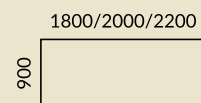
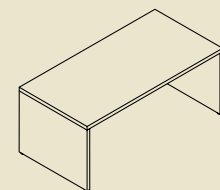

add-on unit

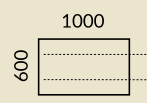
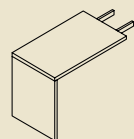

desk for support

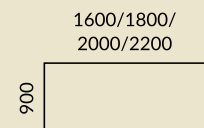
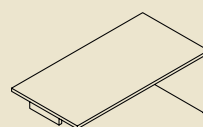

add-on desk

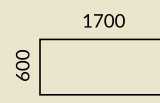
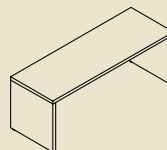

Modesty panel

Zabudowa
Knieblende

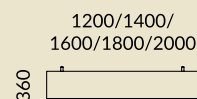
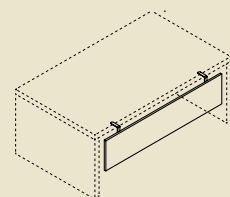

Underdesk sideboard

Szafka podbiurkowa
Unterbausideboard

H: 638 mm

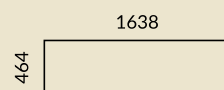
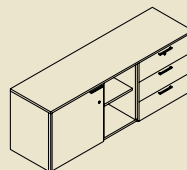

Pedestal

Kontener
Container

H: 638 mm



Conference tables

Stoly konferencyjne — Konferenztische

H: 750 mm

rectangular

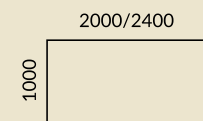
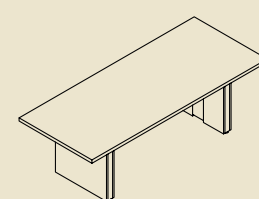

barrel-shaped

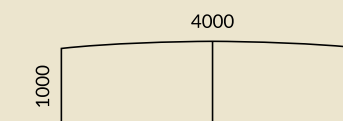
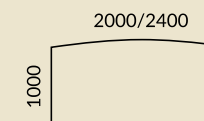
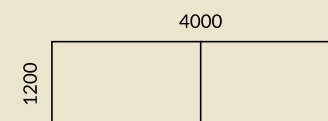
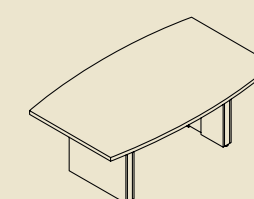
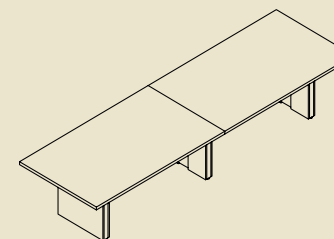

extension module

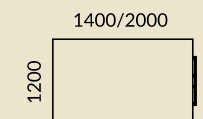
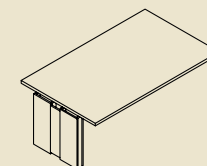

Occasional tables

Stoly okolicznościowe — Besprechungstische

H: 750 mm

H: 500 mm

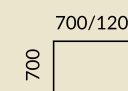
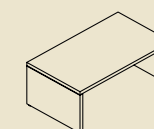
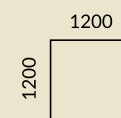
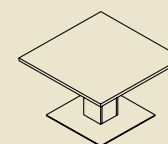



Graf Desk

**Timeless classics
in a minimalist
form highlighted
by stylish detailing**

Graf

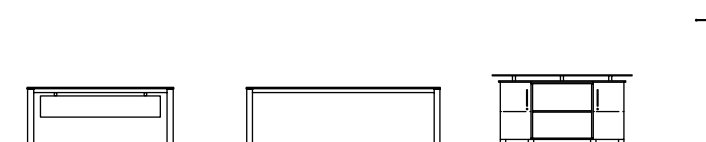

EN | Less is more – this idea that guided us while creating Graf collection. Its exceptional character is enhanced by glass inserts and chromium-plated decorative elements. This is where minimalism meets modernity.

PL | Oryginalna kolekcja Graf została stworzona w oparciu o zasadę, że mniej znaczy więcej. Jej wyjątkowy charakter podkreślają szklane wstawki oraz chromowane elementy dekoracyjne. Tutaj minimalizm łączy się z nowoczesnością.

DE | Weniger ist mehr - dieser Gedanke hat uns bei der Entwicklung der originellen Kollektion Graf begleitet. Ihr außergewöhnlicher Charakter wird durch Glaseinlagen und verchromte Details betont. Hier trifft Minimalismus auf Trends von heute.





1 | Graf - Conference table 2 | Graf - Showcase 3 | System-eM - TV stand



EN | Designer desks, conference and occasional tables as well as showcases fit perfectly into both a focus zone and a meeting area.

PL | Designerskie biurka, stoły konferencyjne, stoliki okolicznościowe i witryny doskonale wpasowują się zarówno w strefę skupienia, jak i miejsce spotkań.

DE | Designschreibtische, Konferenztische, Besprechungstische und Vitrinen eignen sich perfekt für Bereich für konzentriertes Arbeiten als auch Zone für Meetings und Besprechungen.

Aesthetically managed cabling and custom netboxes ensure effortless access to electricity.

Graf



Graf
1 | Desk 2 | Showcase 3 | Hanger

EN | The desks from Graf line can be equipped with netboxes available in MARO's offer. They facilitate work in any office. Additional cable channels guarantee aesthetic cable management.

PL | Biurka z linii Graf można wyposażać w mediaporty dostępne w ofercie MARO, dzięki którym praca zostanie znacznie ułatwiona. Dodatkowe kanały kablowe gwarantują estetyczne poprowadzenie niezbędnego okablowania.

DE | Für mehr Arbeitskomfort können die Schreibtische Graf mit Mediaboxen aus dem Produktprogramm MARO ausgestattet werden. Zusätzliche Kabelkanäle sorgen für sauberes Kabelmanagement.

Office desks

Biurka proste — Schreibtische

H: 750 mm

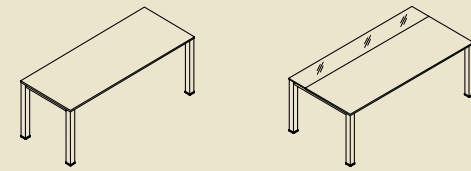
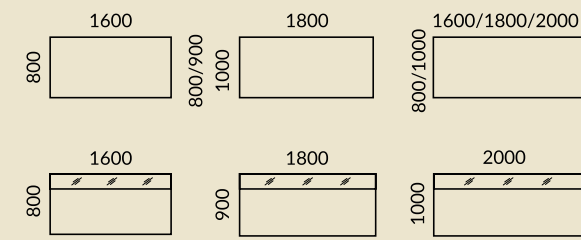

with glass insert

Support desk

Biurko pomocnicze
Anstellisch

H: 750 mm

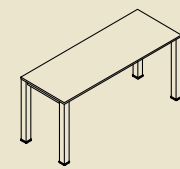
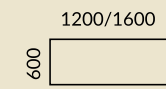

Add-on desk

Przystawka
Anbautisch

H: 750 mm

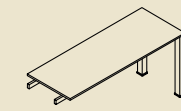
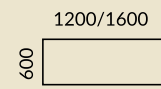

Conference Tables

Stoly konferencyjne — Konferenztische

H: 750 mm

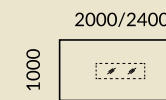

rectangular

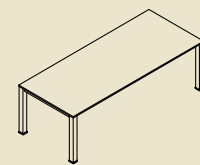

with glass insert

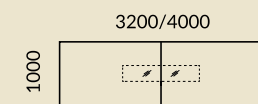
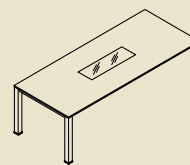

shaped

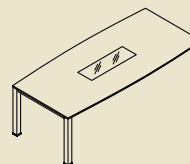
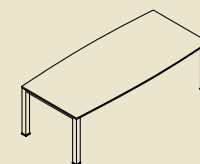

square

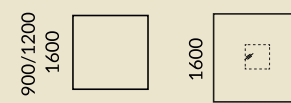
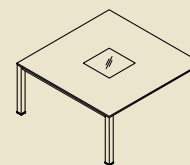
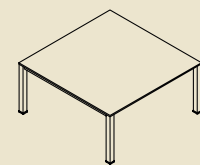

Showcases

Witryny gabinetowe model 01 — Vitrinen Modell 01

2OH H: 900 mm 3OH H: 1270 mm 3OH H: 1270 mm 3OH H: 1270 mm

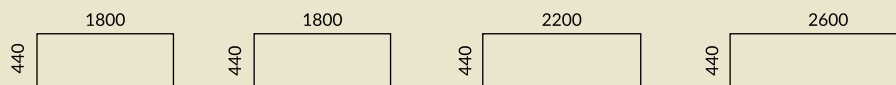
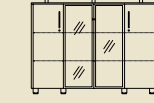
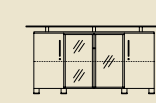
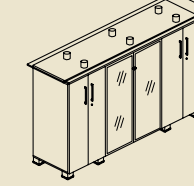
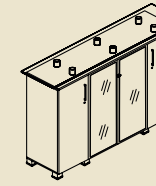
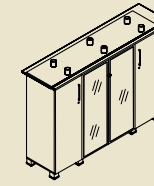
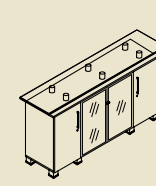
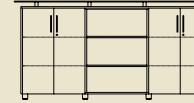
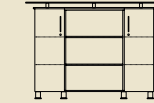
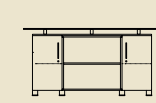
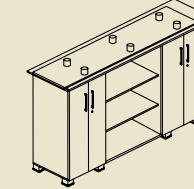
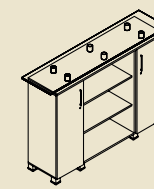
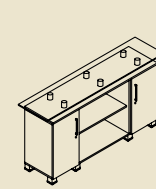

Occasional tables

Stoliki okolicznościowe — Besprechungstische

H: 550 mm

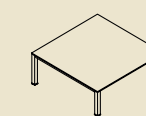
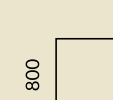
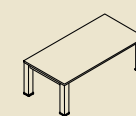
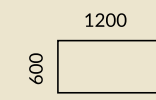

Showcases

Witryny gabinetowe model 02 — Vitrinen Modell 02

2OH H: 828 mm 3OH H: 1198 mm 3OH H: 1198 mm 3OH H: 1198 mm

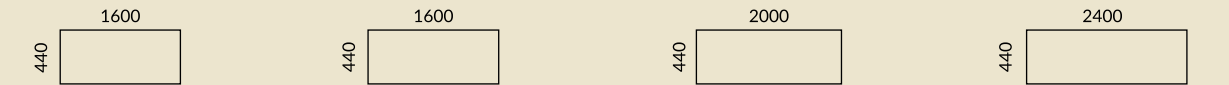
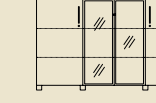
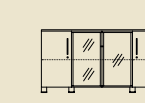
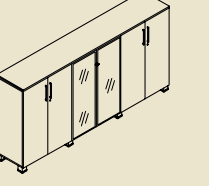
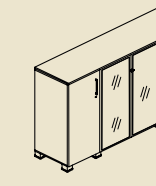
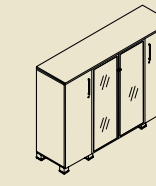
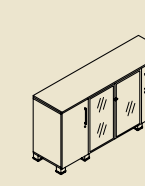
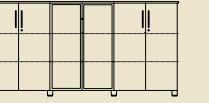
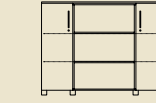
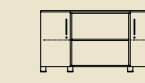
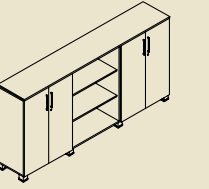
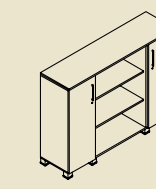
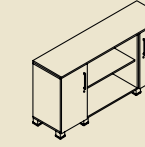

Complementary furniture

Meble uzupełniające — Ergänzungsmöbel

coat hanger





Fineze X Shelf unit

The harmony of lightness and sophistication

Fineze

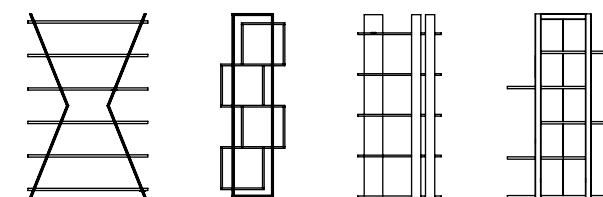

EN | Fineze collection features a large selection of shelf units that can furnish not only executive rooms, but also other office spaces. Thanks to the wide color range, it is surprisingly easy to match the selected model to your current office design.

PL | Kolekcja Fineze obejmuje szeroką ofertę regałów, które można umieścić nie tylko w gabinetach, ale również w innych strefach przestrzeni biurowej. Dzięki szerokiej gamie kolorystycznej bardzo łatwo dopasujemy wybrany model do istniejącej aranżacji.

DE | Die Kollektion Fineze umfasst ein breites Angebot an Regalen sowohl für Chefzimmer, als auch für andere Bürobereiche. Mit der breiten Farbpalette kann jedes Regalmodell in das bestehende Konzept nahtlos integriert werden.



1 | Fineze X2 - Shelf unit 2 | Lusso - Occasional table

EN | Standalone and wall-mounted shelf units guarantee top quality craftsmanship and make your office interior even more stylish.

PL | Regaly wolnostojące i regaly mocowane do ściany to gwarancja najlepszej jakości i eleganckiego wnętrza.

DE | Ob freistehend oder zur Wandmontage, unsere Regale Fineze stehen für beste Qualität und schaffen ein stilvolles Ambiente.

Shelf units

Regaly — Regale

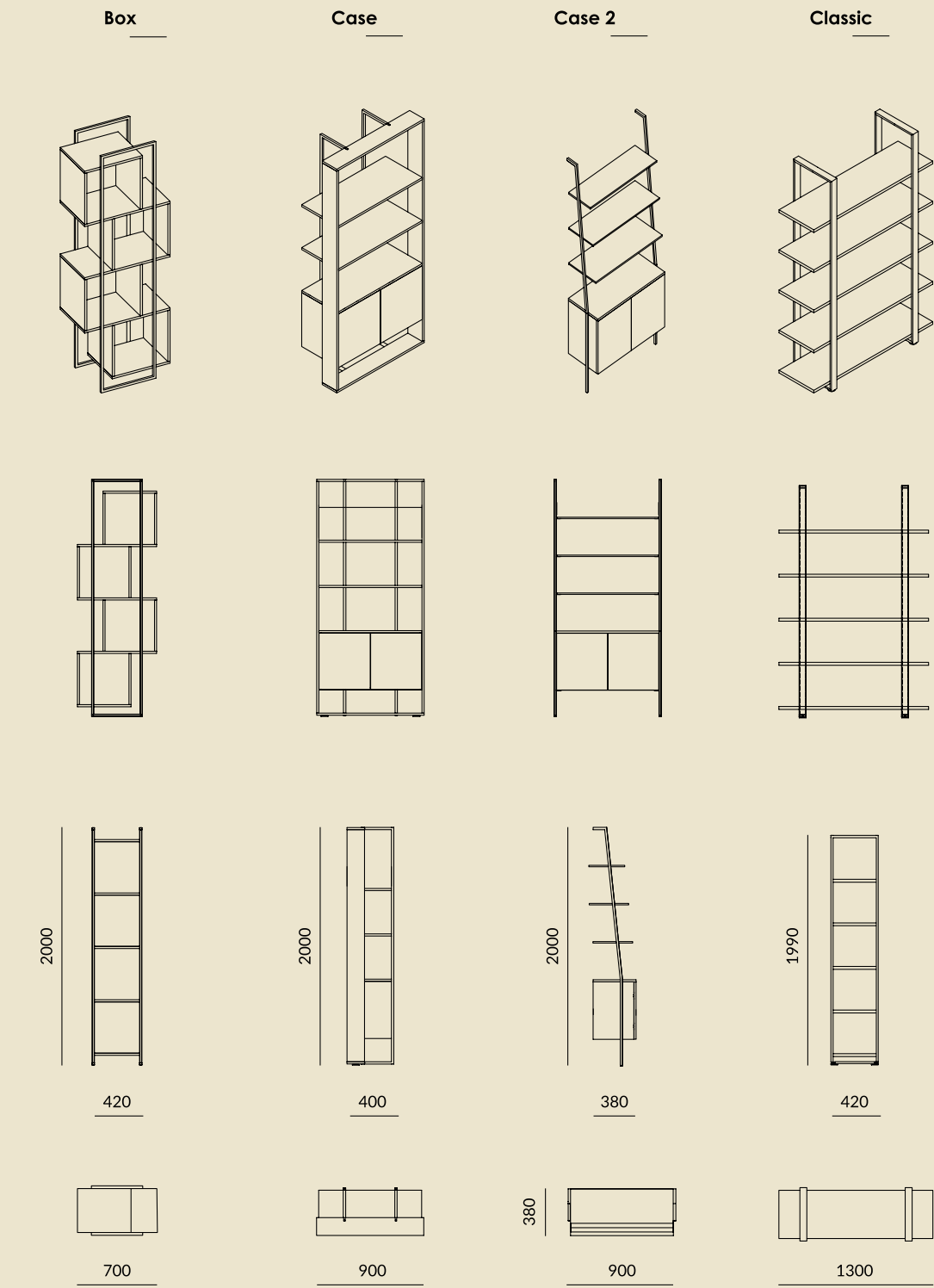

Shelf units

Regaly — Regale

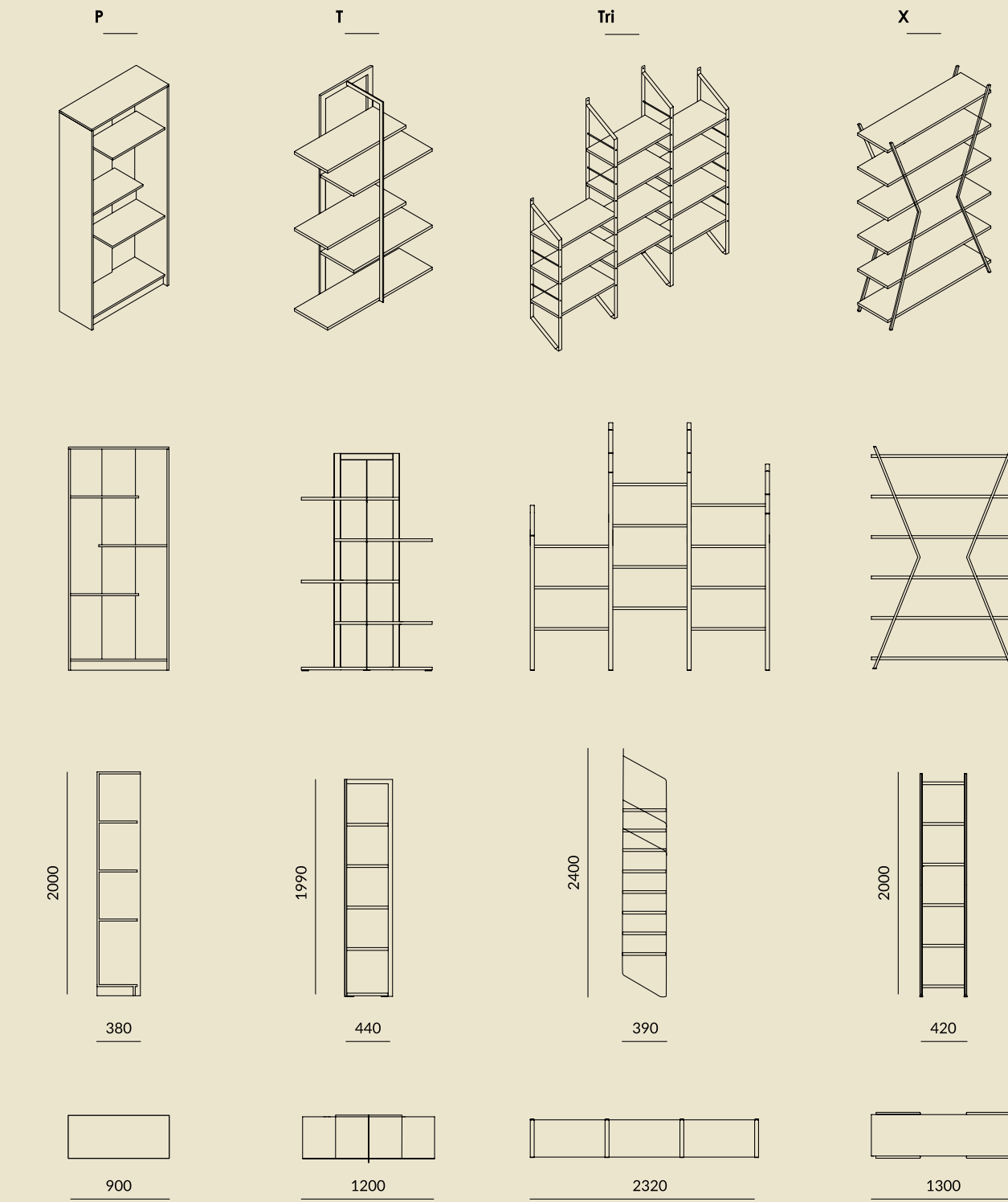

Shelf units

Regaly — Regale

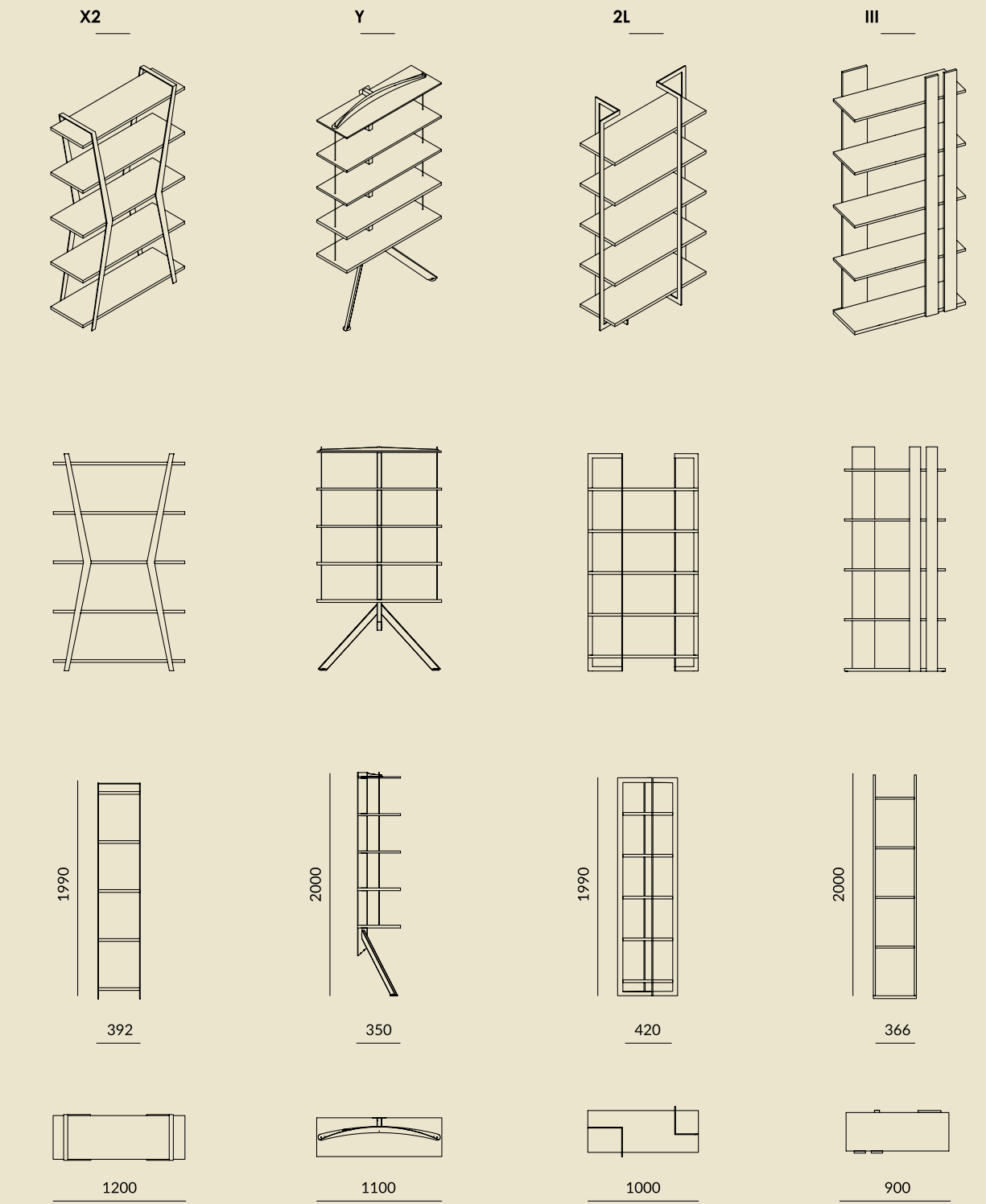



Lusso

1: Lusso - Occasional table 2: Sirtó - Reception counter

Lusso



EN | Lusso is an unusual collection of low occasional tables in a variety of colors and shapes. They are perfect for different office areas such as lobbies and waiting rooms.

PL | Lusso to niezwykła kolekcja, w której znaleźć można niskie stoliki okolicznościowe w rozmaitych kolorach i kształtach. Doskonale sprawdzą się w wielu strefach biura, takich jak lobby czy poczekalnia.

DE | Lusso ist eine außergewöhnliche Kollektion von niedrigen Beistelltischen in einer Vielzahl von Farben und Formen. Sie eignen sich perfekt für viele Bürobereiche wie Wartebereiche und Lobbys.

**Wide choice, large variety
of fabrics and broad
color scheme**



Lusso
Occasional table



EN | Lusso occasional tables distinguish not only by their versatility, but also inimitable design, which combines functionality and elegance. They can complement any office space.

PL | Stoliki Lusso charakteryzują się nie tylko różnorodnością, ale też niepowtarzalnym designem, który łączy w sobie funkcjonalność i eleganckie dopełnienie istniejących już przestrzeni biurowych.

DE | Die Beistelltische Lusso zeichnen sich nicht nur durch ihre Vielfalt aus, sondern auch durch ihr einmaliges Design, das jede Büroumgebung mit Funktionalität und Eleganz aufwertet.

Lusso 1

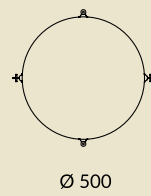
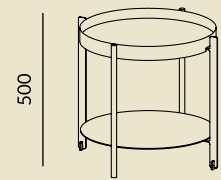
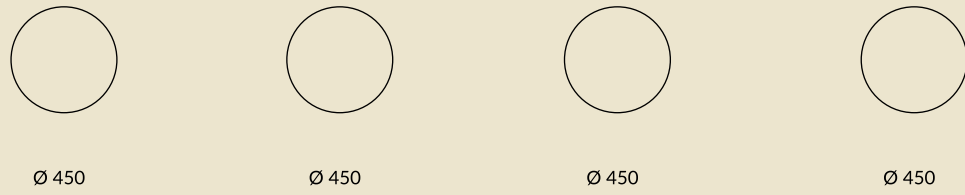
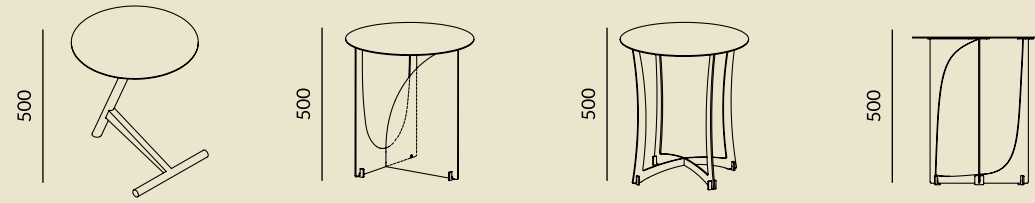
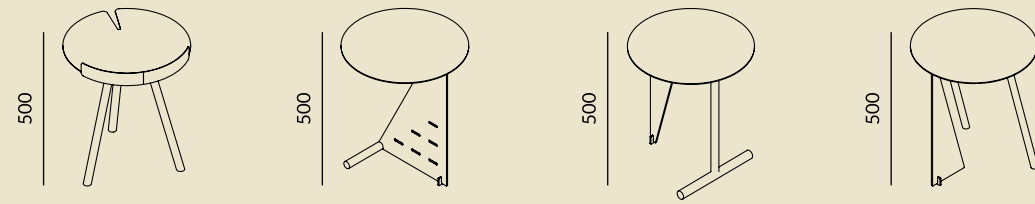

Lusso 2

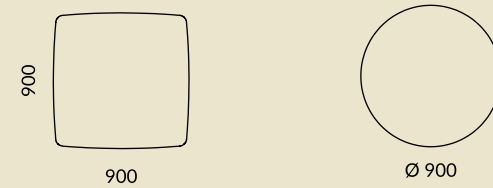
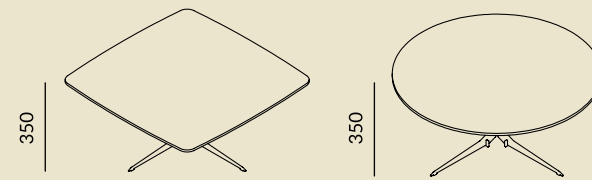
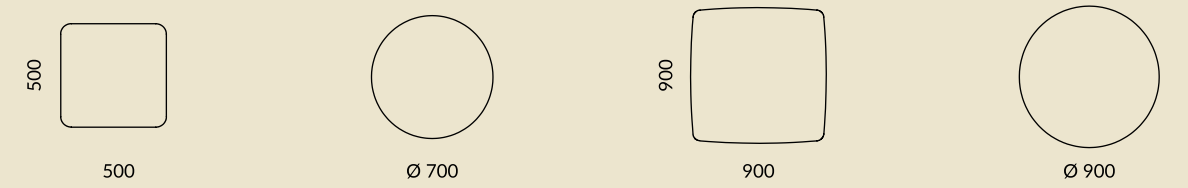
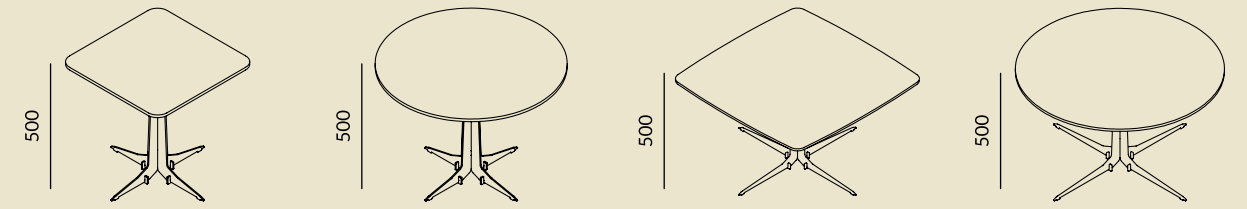

Lusso 3

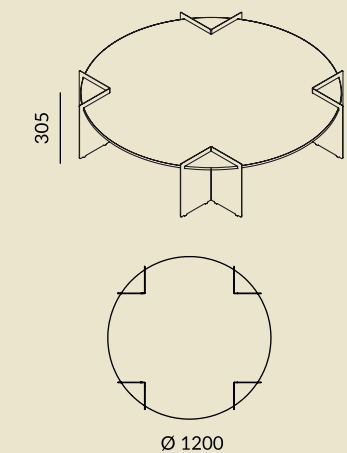
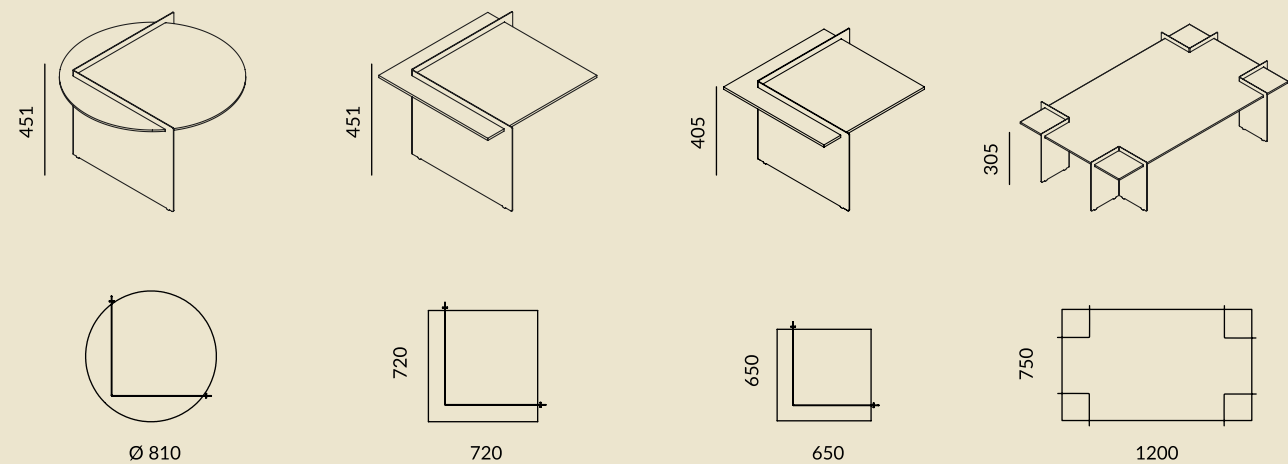

Lusso 4

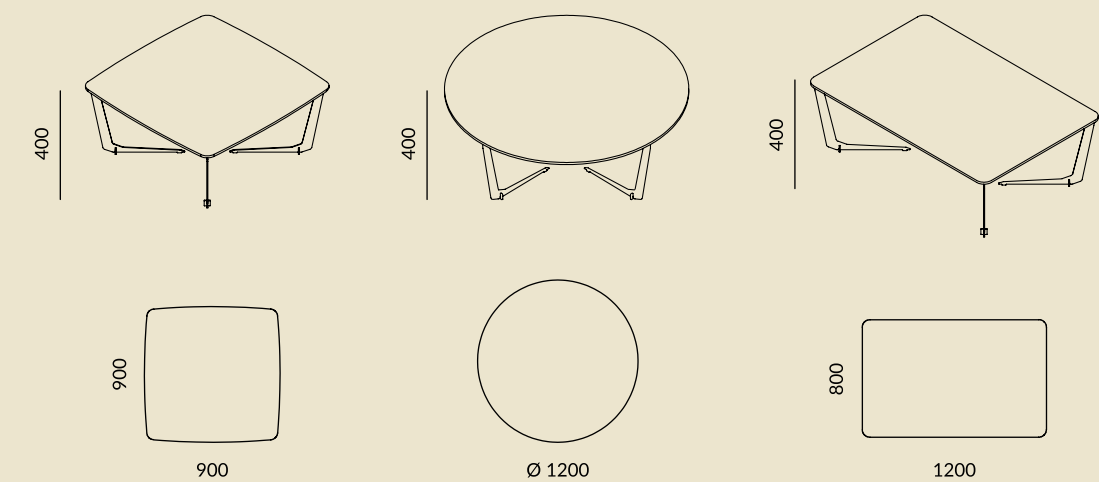

Lusso 5

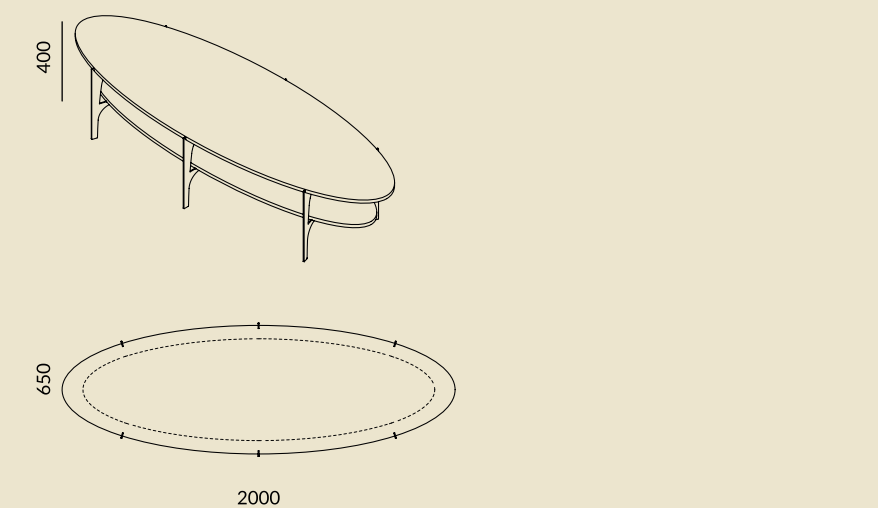
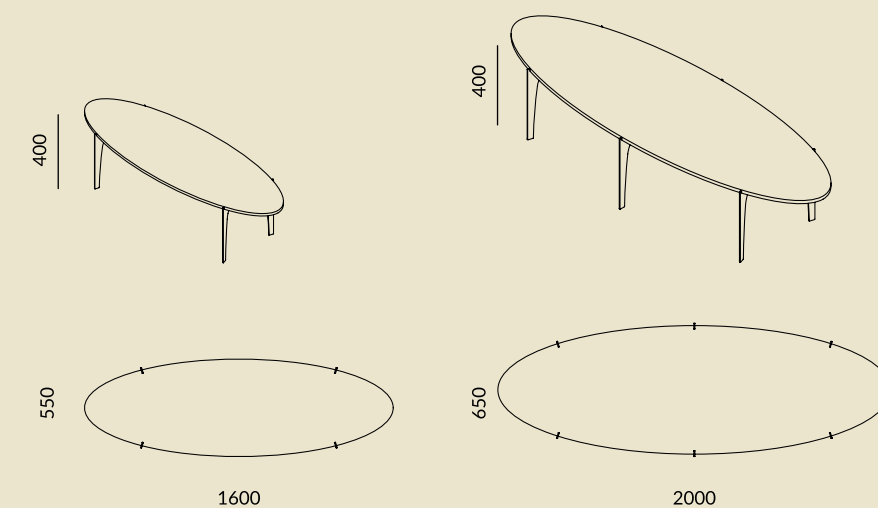
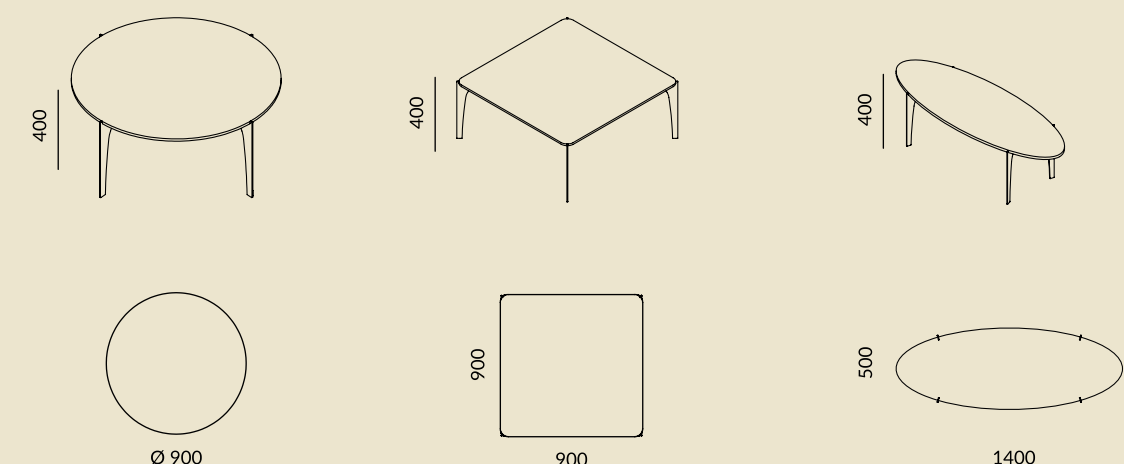

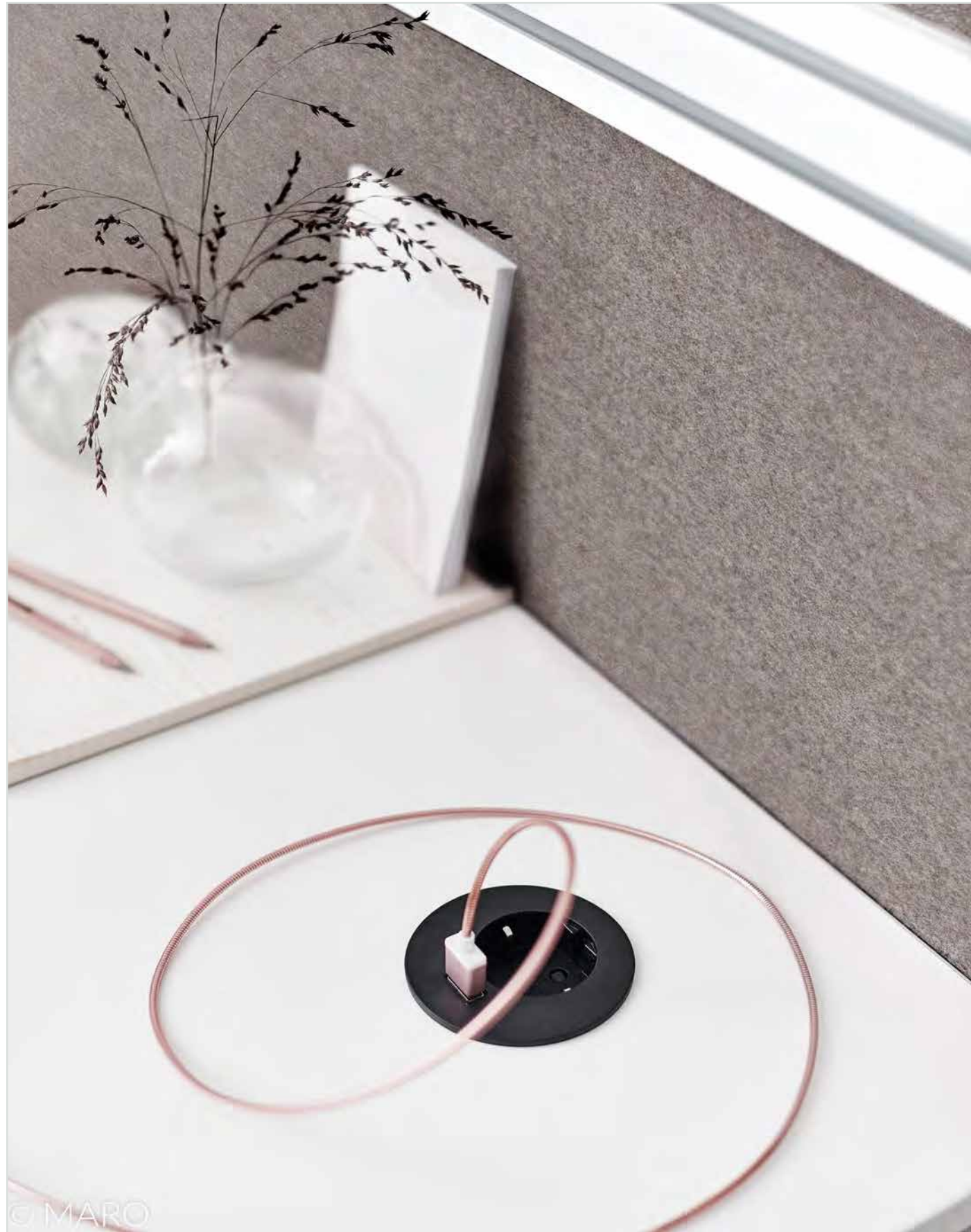

© MARO

Accessories

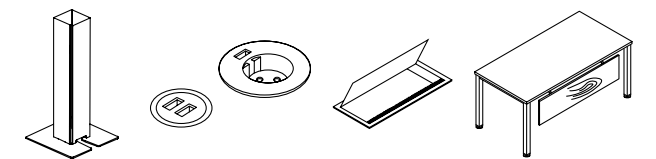



Cable management

Okablowanie — Kabelmanagement

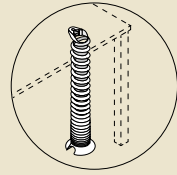

SPRING CABLE CHANNEL

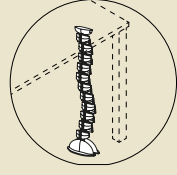

FLEXIBLE CABLE CHANNEL

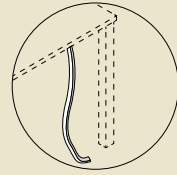

BRAIDED SLEEVE FOR CABLES

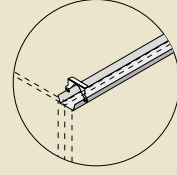

FOLD-DOWN CABLE CHANNEL

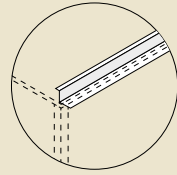

FIXED CABLE CHANNEL

for Toris and Graf

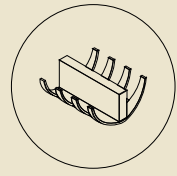

COMB CABLE CLASP

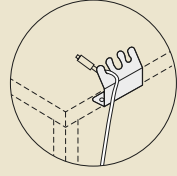

CABLE CLASP

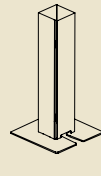

GRAF STANDALONE CABLE LEG

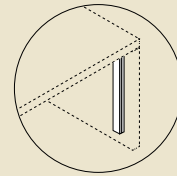

ADD-ON CABLE CHANNEL

Netboxes

Mediaporty
Strom-Daten-Boxen

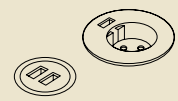

POWER CIRCLE S/M

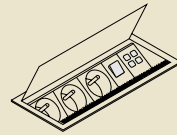

NETBOX

Cable outlets

Przepusty kablowe
Kabeldurchlässe

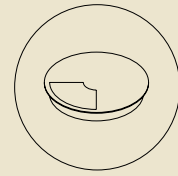

ROUND CABLE OUTLET

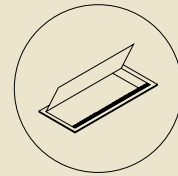

ALUMINUM CABLE OUTLET

Modesty panels

Zabudowy — Knieblenden

for Sirio and Graf

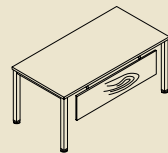

BOARD MODESTY PANEL

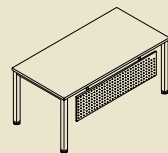

PERFORATED MODESTY PANEL

Notes



Fabryka Mebli Biurowych MARO Sp. z o. o.
PL 62-052 Komorniki,
ul. Fabianowska 100
NIP PL5992575691
T +48 61 890 00 00
E maro@maro.pl

Informujemy o właściwościach i cechach materiałów naturalnych, forniru, kamienia i skóry naturalnej, takich jak: zmienność barwy w obrębie jednego elementu, przeżycienia, nieregularnego usłojenia, mikropęknięcia, dziurki oraz o tym, że nie są to ich wady, lecz zalety. Sprawiają one, że elementy wykonane z naturalnych komponentów, posiadają unikalny i niepowtarzalny charakter dekoracyjny. Fornir dodatkowo, jest nieodporny na ciepło oraz zmienia swoją barwę pod wpływem promieniowania słonecznego. Więcej informacji można znaleźć w instrukcji 'Pielęgnacja i konserwacja mebli MARO'.

Please note that natural materials - veneer, stone and natural leather are distinguished by its unique properties such as: color variation in one element, lining or irregular grain, micro cracks and holes. These are not their disadvantages, but advantages. They make elements made of natural components inimitable and decorative. Additionally, veneer is not resistant to heat and changes its color when exposed to sunlight. More information can be found in "MARO furniture care and maintenance manual.

Niniejsza publikacja nie stanowi oferty w rozumieniu prawnym. MARO zastrzega sobie prawo wprowadzenia zmian w ofertowanych meblach. Prezentowane kolory mogą odbiegać od rzeczywistości. Wszystkie wzory chornione są w Urzędzie Patentowym RP

This publication does not constitute an offer in legal terms. MARO reserves the right to introduce changes to the offered furniture. Presented colors may differ from reality. All designs are protected by the Polish Patent Office.